

Colorado Division of Wildlife
Boreal Toad Research Progress Report
1998



Mark S. Jones (Editor)

April 1999

TABLE OF CONTENTS

List of Figures.....	iii
List of Tables.....	v
Preface.....	vi
HENDERSON/URAD BOREAL TOAD STUDIES by Mark S. Jones	1
SITE DESCRIPTION AND BACKGROUND	1
MATERIALS AND METHODS	4
RESULTS AND DISCUSSION	8
Breeding Site Monitoring: 1998.....	8
Habitat Use and Movement.....	11
Home Range Estimates.....	20
Breeding Site Population Estimates.....	22
REFERENCES	25
APPENDIX 1	27
APPENDIX 2	63
APPENDIX 3	90
PREDATOR COMMUNITIES AND BOREAL TOAD BREEDING SITES by Lauren J. Livo	94
ABSTRACT	95
INTRODUCTION	96
MATERIALS AND METHODS	97
RESULTS	100
DISCUSSION	103
ACKNOWLEDGMENTS	104
REFERENCES	105
MOLECULAR GENETIC ANALYSES OF THE ENDANGERED BOREAL TOAD IN COLORADO AND SOUTHEAST WYOMING by Anna M. Goebel	107
ABSTRACT	108
INTRODUCTION	109
MATERIALS AND METHODS	109
RESULTS	110
DISCUSSION	111
ACKNOWLEDGEMENTS	116
REFERENCES	117

LIST OF FIGURES

HENDERSON/URAD BOREAL TOAD STUDIES by Mark S. Jones

Figure 1.	Site map.....	3
Figure 2.	Map of designated study area in the Henderson/Urad area, 1998.	7
Figure 3.	Use of various slope categories in 1998 by boreal toads using the entire Urad valley as available habitat.....	12
Figure 4.	Use of various slope categories in 1998 by boreal toads using a 300 m buffer around the pooled locations in the Hesbo study area as available habitat.	13
Figure 5.	Use of various slope categories in 1998 by boreal toads using a 300 m buffer around the pooled locations in the Donut study area as available habitat.	14
Figure 6.	Use of various slope categories in 1998 by boreal toads using a 300 m buffer around the pooled locations in the Urad study area as available habitat.	14
Figure 7.	Use of habitat categories in 1998 by boreal toads using the entire Urad valley as available habitat.....	15
Figure 8.	Use of habitat categories in 1998 by boreal toads using a 300 m buffer around the pooled locations in the Hesbo study area as available habitat.	16
Figure 9.	Use of habitat categories in 1998 by boreal toads using a 300 m buffer around the pooled locations in the Donut study area as available habitat.....	17
Figure 10.	Use of habitat categories in 1998 by boreal toads using a 300 m buffer around the pooled locations in the Urad study area as available habitat.....	18
Figure 11.	Comparison of male and female boreal toad daily movement increments (male=113, female=205) at the Henderson/Urad study site in 1998.....	19
Figure 12.	Comparison of home range sizes for male and female telemetered toads at the Henderson Mine in 1998	22

Figure 1. Study sites; circles represent *Bufo boreas* breeding sites and triangles represent sites with no record of *Bufo boreas* breeding. 98

Figure 2. Distribution of predicted probabilities for pond status (ponds with a probability score > 0.5 are expected to be boreal toad breeding sites, whereas ponds with a probability score < 0.5 are expected to have no record of boreal toad breeding). Pond numbers are displayed along the x-axis. 101

Figure 3. Comparison of total numbers of *Ambystoma tigrinum* and *Dystiscus* larvae and adults in boreal toad breeding ponds (pond status = 1) and ponds with no record of boreal toad breeding (pond status = 0). 102

MOLECULAR GENETIC ANALYSES OF THE ENDANGERED BOREAL TOAD IN COLORADO AND SOUTHEAST WYOMING by Anna M. Goebel

Figure 1. PHYLOGENY OF THE *BUFO BOREAS* SPECIES GROUP BASED ON MITOCHONDRIAL DNA DATA. Single most parsimonious tree. Branches are drawn proportional to their length. Clade names and localities are identified within the tree. Sample sizes are based only on samples for which complete control region sequences were available. Many more samples were analyzed for each clade. For example, partial data that identified major clades were obtained for over 200 samples from the Southern Rocky Mountain group. 112

Figure 2. PHYLOGENY OF EASTERN *BUFO BOREAS* BASED ON NUCLEAR AFLP DATA. Neighbor-joining tree. Localities are identified to the right of the tree. Individual samples that were found in alternate localities are identified within the tree. 114

LIST OF TABLES

HENDERSON/URAD BOREAL TOAD STUDIES by Mark S. Jones

Table 1.	Contact statistics for radio tagged boreal toads in the Henderson/Urad study area in 1998.....	5
Table 2.	Home range estimates for radio telemetered toads in the Henderson Mine area in 1998.	21
Table 3.	Cumulative boreal toad home range estimates by site from the Henderson study area.....	21
Table 4.	Population estimates for male boreal toads at the breeding sites in the Urad/Henderson area from 1995 to 1998.....	23

PREDATOR COMMUNITIES AND BOREAL TOAD BREEDING SITES by Lauren J. Livo

Table 1.	Estimated daily rates of consumption of <i>Bufo boreas</i> tadpoles by selected predators.	99
Table 2.	Variable means, associated Chi Square values, and comparison between boreal toad breeding sites and sites without record of boreal toad breeding.	100
Table 3.	Correlation matrix for variables used in logistic regression (probabilities in parentheses).	102

Preface

The Boreal Toad Recovery Team was formed in 1994, in response to reports of significant declines in boreal toad distributions in the Southern Rocky Mountains. These apparent declines resulted in an “Endangered” listing by Colorado and New Mexico, and a “Status 2” species designation in Wyoming. The boreal toad is currently considered “warranted but precluded” for federal listing under the Endangered Species Act. The first Boreal Toad Recovery Plan was completed in 1997 under the direction of John Goettl; the Recovery Plan and Conservation Agreement have now been combined into one working document (Loeffler [ed.] 1998). Currently, the Boreal Toad Recovery Team is coordinated by Chuck Loeffler, Wildlife Manager of Reptiles, Amphibians, Mollusks, and Crustaceans for the Colorado Division of Wildlife (CDOW).

This report represents boreal toad research sponsored by the CDOW in 1998 by several researchers and has been consolidated into a single document to make this information available to members of the Boreal Toad Recovery Team and other interested parties. The various sections of this report cover results of:

- Research conducted by the CDOW on habitat use, movements, and general life history aspects of boreal toads at the Climax Molybdenum Company mine near Empire, Colorado. Mark Jones is the principal investigator.
- Research conducted by the CDOW on boreal toad tadpole ecology. The principal investigator is Lauren J. Livo.
- Research conducted under a CDOW MOU with the University of Colorado at Boulder on the molecular genetic determination of management units within the Southern Rocky Mountain population of boreal toads. The principal investigator is Anna M. Goebel.

Funding for boreal toad research and recovery efforts in Colorado is provided through Great Outdoors Colorado.

SITE DESCRIPTION AND BACKGROUND

Research on population size, stability, movement, and habitat use is currently being conducted at the Henderson/Urads Mine where the largest known breeding population of boreal toads in Colorado exists. The Henderson Mine breeding locality consists of numerous ponds and wetlands in an area that is heavily disturbed due to molybdenum mining by the Climax Molybdenum Company. The mine is located west of Empire, Colorado at an elevation range of 10,000 to 10,500 feet. The specific breeding sites have been designated as follows: 2-pond, Power Alley, Hesbo, Treatment Pond, Donut, Anne's Pond, and Upper Urads (Figure 1). In 1998, egg masses were located at five additional sites at the mine, with survival to metamorphosis at two of these sites.

Hesbo and 2-Pond were the main breeding locations in 1995 and 1996. Hesbo was the primary breeding site in 1997 and 1998. In 1995 and 1996 both sites were influenced by pre-treated mine effluent running through them at an elevated temperature of 19-21°C. Climax finished a new water treatment facility on the Urads side of the facility in 1997. As a result, 2-Pond was not an active breeding site in 1997, and Hesbo has reduced water temperatures in the spring and no long-term source of water. As a result of the changes in water supply to Hesbo, we had to pump water to the site once each week from July to September during the 1998 season. In an attempt to remedy this situation, the Mine provided a backhoe to install a dam and water control structure and increase the depth of the channel in October 1998. Even though Hesbo has the largest adult population during breeding season, no recruitment was observed from 1995 to 1997. In 1998, Lauren Livo removed Dyticid beetle larvae from the Hesbo site as part of her research, resulting in substantial survival to metamorphosis.

Power Alley is a beaver pond complex along the west branch of Clear Creek and is the most natural breeding site in the area. It is not directly influenced by mine effluent and therefore the water temperature is colder than the previously mentioned sites and breeding takes place one to two weeks later. This site, however, has dried up during the last two years and the egg masses were desiccated.

Treatment is the eastern most of several ponds previously used to treat water from the mine tailing dams in this valley. It does not have a large number of adults during breeding season but produced 10,000-15,000 toadlets in 1996, 1997, and 1998. Recruitment at this site is low, as there is minimal winter refuge for toadlets.

Donut is a newer pond above the water treatment facility. This site typically has 5-6 egg masses but because it is higher in elevation than the other sites, breeding occurs later making weather conditions post metamorphosis critical to toadlet survival and dispersal. In addition, there are few suitable hibernaculum close to this site. All toadlets froze in 1995 and 1996. We believe that some toadlets survived in 1997. Survival to metamorphosis was good in 1998, presumably a result of increased vegetation and small mammal burrows on the islands.

Anne's Pond is a small wetland area south of Donut and is fed by ground water and runoff. Because the average depth is less than 10 cm, the water temperature stays warm and tadpoles grow quickly. In 1996 this pond had several thousand tadpoles but dried up in July. At our request, the Henderson Mine personnel put in a pipe to keep the water level constant, which resulted in successful recruitment in 1997 and 1998. In October 1998 we used a backhoe to increase the main channel depth and added a side channel; these channels drain to a deep-water thermal refuge.

Upper Urad is a large wetland area at the western end of the valley at an elevation of 10,500 ft. Due to the elevation, this is the last site for breeding activity each year. It produced toadlets in 1995 and 1996 but they froze in 1995 and were eaten by sandpipers in 1996. No successful reproduction occurred in 1997 or 1998 at this site.

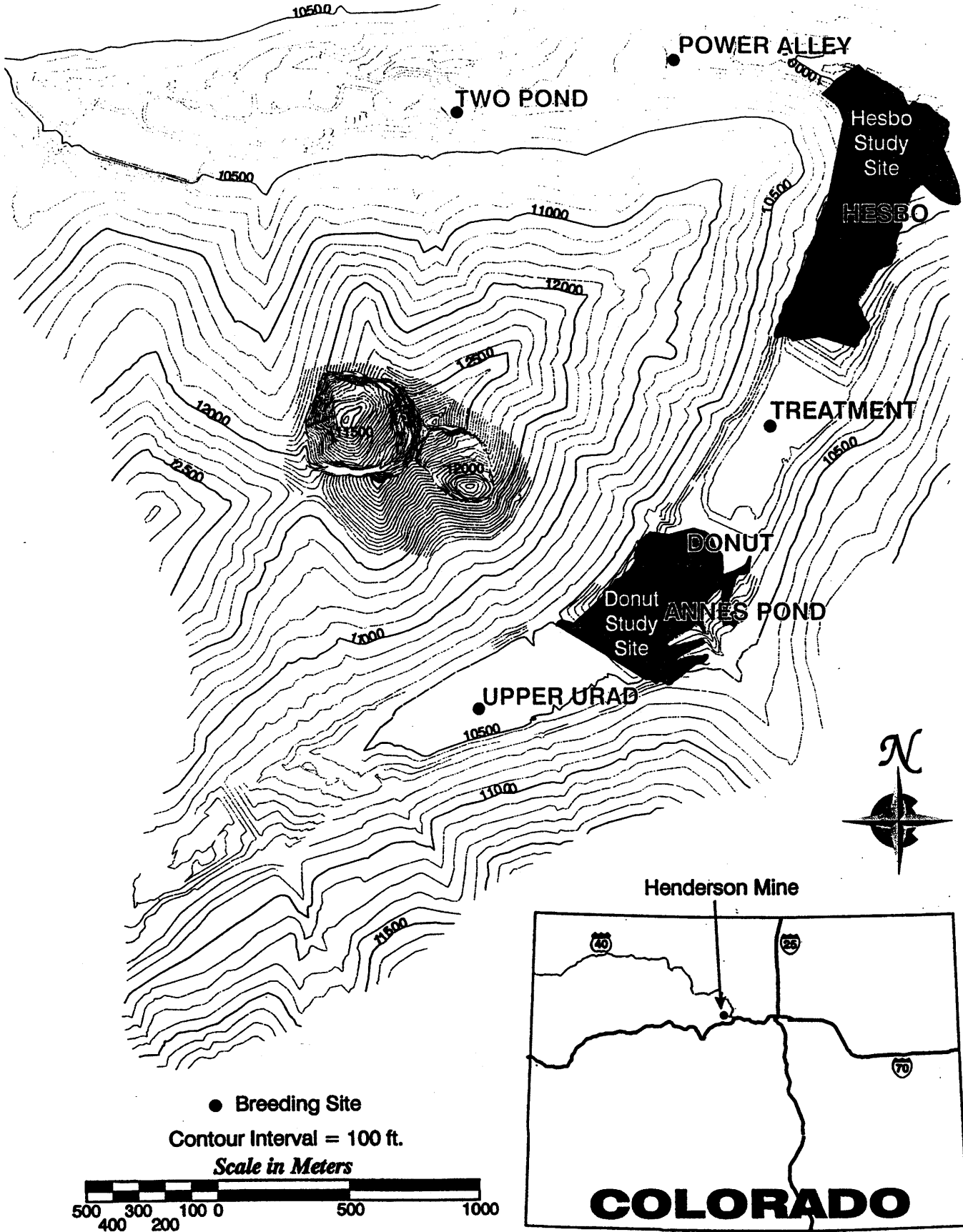

Figure 1. Site Map

MATERIALS AND METHODS

The Henderson/Urad breeding population was monitored by J. Goettl from 1995 to 1996. Data collected in 1995 was mostly exploratory in nature, as little was known about the status of these breeding sites, and field techniques for radio telemetry were still being refined. This project was transferred to M. Jones in 1997. Starting in 1996, all breeding sites were surveyed one time during daylight hours and one time at night each week during the period when toads were actively breeding. Each site was surveyed according to the protocols outlined in the Conservation Plan and Agreement (Loeffler [ed.] 1998). Each toad captured during the night surveys was sexed, weighed (± 0.1 g), and measured (snout to urostyle length, ± 0.01 mm). Each individual was then scanned for a PIT tag and if one was not found, a tag (AVID ITI-125S) was inserted dorsally. The tags were inserted by pinching the skin on the toads back (slightly off center and anterior), making a small incision using sterile scissors, inserting the sterile tag in a posterior direction using forceps, and closing the incision using surgical adhesive. All PIT tag numbers were recorded along with other pertinent data on individuals and site. Water quality samples were taken at each breeding site a minimum of three times per year. Once in May, one time while tadpoles were present, and again during metamorphosis.

Twenty-six toads (nine males and seventeen females) were radio tagged in May and June, 1998 at Hesbo and Donut with Holohil BD-2G radio transmitters weighing 2g each, with an expected battery life of six months. The radios were fixed to the toads using a waist harness constructed of plastic coated fishing leader material fastened with crimp collars inside 2mm vinyl tubing. Seven additional toads (two males and five females) were tagged during the summer as replacements for individuals killed by various predators (Jones et al, in press) or which lost their transmitters (Table 1).

Each radio tagged toad was located one time per week from May until they went into hibernation. Toad locations were recorded in Universal Transverse Mercator (UTM) coordinates using a Trimble Pathfinder Basic Plus global positioning system (GPS) with an external antenna. Location files were downloaded to a computer, differentially corrected, and imported into ARC/INFO (ESRI 1997) for spatial analysis.

Central to the study of boreal toad biology is their use of various habitats and our ability to define their habitat requirements and preferences. This process involves defining the availability of individual habitat types within the study area and then determining the usage of those habitats. We can determine individual use of various habitats through our radio tracking activities; defining what is available is not as easy, and in almost all studies involving habitat selection, this is a subjective decision based on the researchers knowledge of the animals movement. By changing the spatial scale of what an investigator deems to be available to an animal or if habitat types are arranged in an aggregated pattern (Porter and Church 1997), the resultant conclusion about selection or preference for individual habitat types will also change. For this reason, we used two different spatial scales to define habitat availability.

Table 1. Contact statistics for radio tagged boreal toads in the Henderson/Urad study area in 1998.

Toad ID	Start date	Sex	Contacts	Monitored (days)	Comments
350	06/24/98	M	15	97	Hibernating in hole under spruce by Anne's pond.
386	07/07/98	F	13	84	Hibernating under large rocks N side of road across from Donut.
471	07/28/98	M	10	64	Hibernating near spring in rocks below Hesbo.
476	07/08/98	F	14	90	Hibernating in hole at base of a hill.
477	07/22/98	M	2	6	Found in road, dead.
482	06/30/98	M	14	93	Hibernating in hole at retaining wall, N side of Urad Lake.
486	06/30/98	F	2	2	Radio fell off.
487	08/12/98	F	8	48	Hibernating in hole in spring & peat moss Under Spruce tree.
490	07/29/98	F	11	70	Hibernating in hole by spruce tree.
571	06/23/98	F	4	20	Killed by predator.
572	05/15/98	F	22	137	In grassy spring 50 ft below Upper Urad.
574	05/15/98	F	23	137	Found 2 ft above hole in aspen/conifer.
575	06/23/98	F	3	14	Radio fell off.
576	05/15/98	F	10	53	Toad was eaten.
577	05/15/98	F	11	67	Toad was eaten by raccoon.
578	07/06/98	F	12	78	Hibernating in hole in log by spring.
579	05/15/98	F	22	144	Hibernating in hole 30 ft above the road by the Boulder field.
580	05/15/98	F	20	137	Hibernating in hole under Urad road in willows.
581	05/15/98	F	10	53	Radio failed
582	05/15/98	F	8	59	Killed by predator.
583	05/18/98	F	19	134	Hibernating in hole on berm below Hesbo.
585	06/03/98	M	18	118	Hibernating in hole under rock , S side of Ruby Creek.
587	05/28/98	M	11	70	Radio fell off.
588	06/09/98	F	17	112	Hibernating up hill 120 yds under willow by spring.
589	06/03/98	M	18	118	Hibernating in hole under fir by spring below Anne's Pond.
590	06/09/98	F	7	44	Radio fell off.
591	06/03/98	M	3	14	Radio fell off.
592	06/03/98	M	18	118	Hibernating in hole under fir where spring starts below Anne's Pond.
771	05/15/98	F	6	25	Radio fell off.
773	05/15/98	F	10	38	Radio fell off.
919	05/25/98	M	17	127	Hibernating in hole by spring below Anne's Pond.
920	05/19/98	M	5	28	Radio fell off.
922	05/28/98	F	5	26	Found in NE corner of Donut dead.





First, we combined all three study areas (Hesbo, Donut, and Upper Urad) because we know from our telemetry work during the last two years that toads can move from one end of the valley to the other and we have seen some interaction between study areas. For the second analysis, we defined availability of habitat types for each study area (because toads generally stayed within their respective area) by drawing a 300 m buffer around the pooled toad locations for each study site, and calculating the availability of each habitat type within that polygon (Figure 2).

Habitat and slope coverages were developed in ARC/INFO starting with a photo interpreted CAD file obtained from the Henderson Mine. Corrections were made through ground truthing and walking the perimeter of each habitat area with a GPS unit. Toad location data was overlaid on the habitat and slope coverages to assign habitat types to each location. The habitat categories were defined as aspen/conifer, road, spring, stream, lentic water (lake, reservoir, pond), and rock/grass. In addition, a photograph was taken at each toad location each week to verify the habitat classifications assigned in ARC/INFO. Only toads with six or more habitat locations were included in the analysis. To test whether toads used a habitat category in greater or lesser proportion than its availability in the study area, a univariate t-test was used in SAS (1994). This tests whether the difference between the mean of the proportion of habitat availability and the mean of the proportion of habitat use equaled zero ($\alpha=0.05$).

Home range analysis was conducted to quantify and evaluate the areas and habitats used by individual boreal toads. Home range estimates were produced on two temporal scales for each boreal toad. One estimate used all the radio-tracking locations and the other estimate only included post-breeding locations. An area use estimate was also calculated for each breeding site from pooled individual locations for that site. The minimum convex polygon and adaptive kernel (Worton 1989) methods were used to estimate the home ranges for all individuals that had six or more radio-tracking locations. The program CALHOME (Kie et al. 1994) was used to calculate these estimates.

Minimum convex polygon (MCP) is a common home range estimation method that assumes a uniform utilization distribution (Samuel and Garton 1985). With the MCP method, any area inside the polygon has an equal probability of containing a location. MCP is calculated by drawing a polygon around a specified percentage of the radio-tracking locations. Ninety-five percent of the locations were used for these estimates. MCP has the disadvantages of increasing the size of the home range estimate as the number of location's increases and not allowing for a precision estimate (White and Garrott 1990). MCP was useful, however, to get an idea about the minimum size and shape of home ranges and use areas. Many of the utilization distributions are linear between two core areas; MCP included these corridors in the estimates.

Legend

-  Lake or pond
-  Conifer/Aspen forest
-  Unimproved road
-  Stream
-  Spring

Other areas consist of
rock base/grass interspersion

- A. Hesbo site - 300 m buffer
- B. Donut site - 300 m buffer
- C. Upper Urad site - 300 m buffer
- D. Henderson/Urad drainage

Scale = 1:15000

Meters

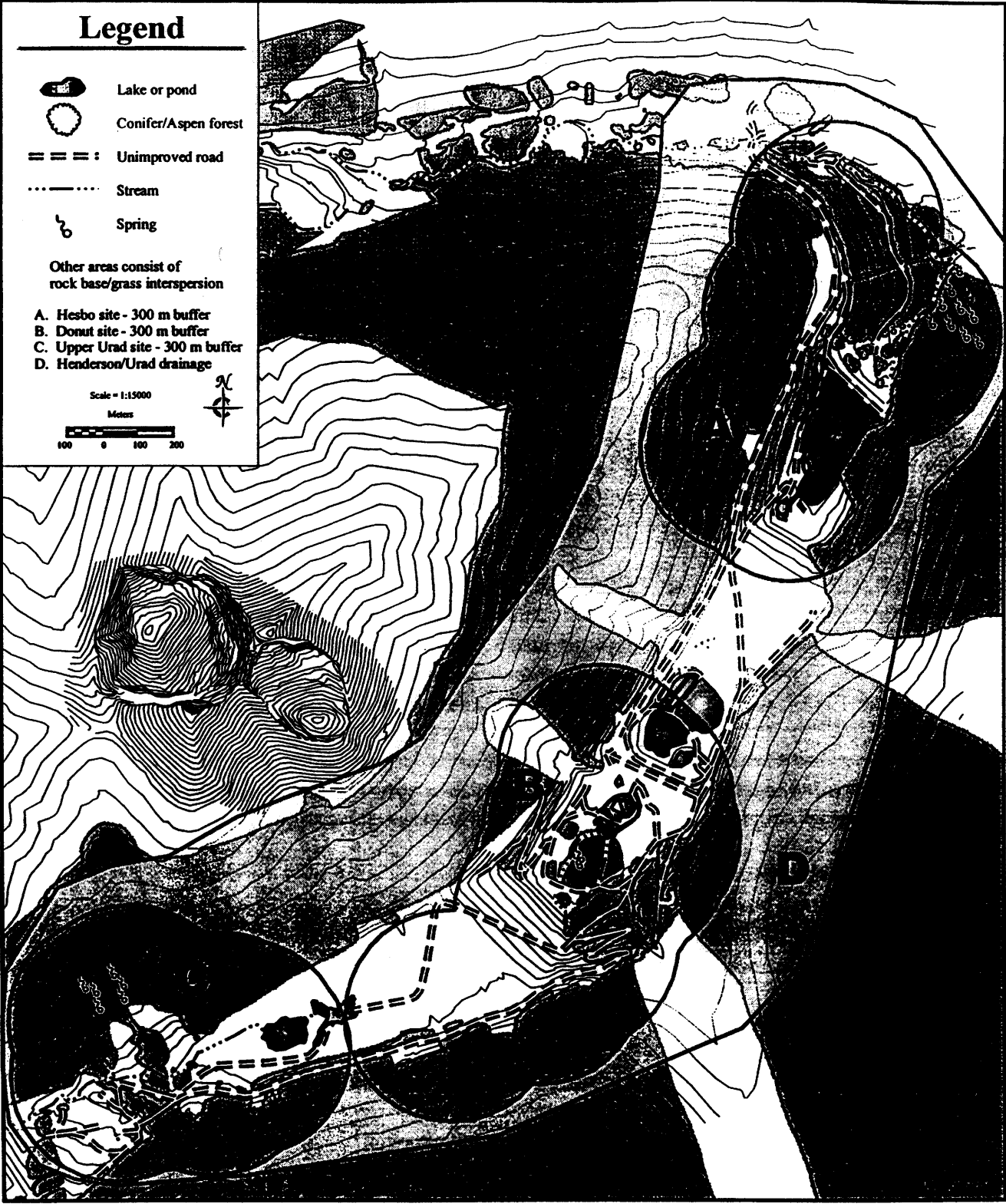

Figure 2. Map of designated study areas in the Henderson/Urad area, 1998.

The adaptive kernel method (Epanechnikov kernel) is a nonparametric method that uses point percentage contours to estimate a utilization distribution for the sample locations (Worton 1989). It delineates the smallest area that contains a specified percentage of the probability distribution. The adaptive kernel method was used in addition to the MCP in order to estimate areas of the home range where no locations were obtained such as foraging or nocturnal movements. This method was also chosen because it does not assume a normal or uniform distribution and is therefore capable of estimating home ranges for animals with core activity areas (Kie et al. 1994). This attribute was attractive because the radio-tracking locations for many individuals were not normally distributed. Many of the boreal toads studied appeared to move periodically to areas such as water sources or the breeding site. A 95% point probability and the default grid size (30x30) were used. A bandwidth of 50 meters was chosen in these estimations. The bandwidth is the smoothing parameter that controls the amount of variation in the estimate (Worton 1989). A bandwidth of 50 meters was selected to allow the identification of core activity areas in even a relatively small home range. The goodness of fit of the bandwidth to the data is identified by a least square cross validation test (LSCV) (Kie 1994). The lower the LSCV score, the better the bandwidth and subsequently the polygon fit to the locations. For example, two core areas with a polygon around each of them would have a lower LSCV score than a larger polygon that encompasses both core areas.

Capture-recapture methods were used to estimate population numbers of males at each breeding site from 1995 to 1998. Only male boreal toads could be estimated, as there was never a recapture of a female in the same year, indicating female's breed and immediately leave the breeding site. The computer program Capture (White et al. 1978) was used for the analyses and White et al. 1978 should be referenced for a full description of procedures and model selection.

Movement was calculated by plotting sequential locations for each toad on a 3 m² cell digital elevation model in ARC/INFO. In this way, the extreme unevenness of terrain elevations could be incorporated into the calculations. Total distance moved/time for each toad and average daily movement in meters was calculated. Differences between male and female movements were tested using the Mann-Whitney U test.

RESULTS and DISCUSSION

Breeding Site Monitoring: 1998

Hesbo- Hesbo was monitored at night, weekly from May 12 to May 26, 1998. Additional biweekly daylight surveys were conducted throughout the summer. The peak of breeding activity occurred on May 26 with 98 adults observed (96 male, 2 female). Night surveys were discontinued because all of the adults handled had been previously handled in 1998. Eighteen egg masses were laid, resulting in approximately 20,000 tadpoles. During 1998, Lauren Livo conducted dytiscid beetle larvae predation studies at this site.

2-Pond-

As a result of water quality changes in 1997, as previously described, 2-Pond was no longer considered a viable breeding site and was not monitored at night in 1998. During a day survey on June 22, 1998, small tadpoles were observed. We estimated there were two egg masses laid at this location. The tadpoles never developed to metamorphosis. Poor water quality (elevated heavy metals) was probably the cause of the delayed development as shown by Brinkman in Jones et al 1997.

Power Alley-

Power Alley was monitored weekly, at night, from May 27 to June 3, 1998. The most adults observed at this site was 68 (66 males, 2 females). Two egg masses were laid at this site: both desiccated. Tadpoles were later moved from Anne's Pond, Donut, and John's Pond into the upper pond at Power Alley. This pool has constant flowing spring water providing stable water conditions and an excellent refuge for eggs or tadpoles that were in trouble in other locations. This pond produced approximately 2,000 advanced tadpoles that developed normally to metamorphosis and dispersed.

Upper Urad-

Upper Urad was monitored weekly, at night, from June 2 to June 23, 1998. Ten adults, including two gravid females, was the highest number of toads observed on any occasion at this location. No egg masses were observed and no successful reproduction occurred in 1998.

Donut-

Donut was monitored weekly, at night, from May 26 to June 23, 1998. Thirteen egg masses were deposited and one egg mass was moved to the upper pond at Power Alley, the remainder hatched and developed normally. It was difficult to estimate the number of tadpoles this year as they utilized the entire pond, whereas in other years, they were primarily confined to the southwest corner. Lauren Livo conducted tadpole ecology experiments at this site. Although some toadlets died from desiccation and exposure, we believe survival was better than in previous years because many metamorphosed and moved onto the islands, which are thickly vegetated and have suitable hibernaculum close to the edge of the water.

Treatment-

Treatment was monitored at night from May 27 to June 8, 1998. Four adults were the most observed in one night. No egg masses were found, but based on the number of tadpoles observed on August 5 (>10,000), we suspect four to five egg masses were present. Monitoring was continued at this site throughout the summer and we estimated survival to metamorphosis was low. It is unlikely that very many survived the winter, as there are no suitable hibernacula around this site.

Anne's Pond-

Anne's Pond was monitored from May 26 to June 23, 1998. The most adults observed in one night was 24, we checked a total of 12 females during the course of the active breeding period. Twelve egg masses were found and based on the history of this pond drying up in previous years, we refilled it with water from Ruby Creek each week. Anne's Pond contained approximately 25,000 tadpoles, half of which probably reached metamorphosis and successfully dispersed. In October, we dug a main channel with a side channel down the middle of the pool to increase the volume and prevent tadpoles from becoming stranded as the water level goes down. We have essentially produced a very active breeding site where one did not previously exist.

Other New Breeding Sites

1- Pond-

Boreal toads have never been observed breeding in 1-Pond in previous years presumably because prior to 1997 it was a settling pond for untreated mine effluent. In 1998, 1-Pond was fed only by a spring seep and >5,000 very large tadpoles from at least two egg masses were observed on July 29. Most of the tadpoles metamorphosed and dispersed. It looked like there would be excellent recruitment from this site as there are good hibernation locations around the edge of the water.

John's Pond-

John's Pond is a small catch basin by the domestic water treatment plant on the Henderson side of the mine. We were informed by mine personnel on July 29, 1998 that there were tadpoles in this location. We observed approximately 4,000 large tadpoles in a pool approximately 3m x 3m. Since we had some concern as to whether there would be appropriate cover for hibernation at this site, we moved about half to the upper pool at Power alley.

Flume House-

Flume House was another location reported to us by mine personnel. We were notified of tadpoles at this location on July 29, 1998. Upon inspection, there were approximately 2,000 very small tadpoles. These never developed leg buds prior to winter.

Lower Urad Lake-

This was the first year we observed breeding in Lower Urad Lake. On August 18, approximately 300 tadpoles were observed in the north west cove. Emerging toadlets were also observed at this time. There should be some recruitment at this location.

Climatic conditions each year have a major impact on recruitment. Spring storms frequently kill egg masses and early fall freezing conditions either directly kill toadlets or negatively impact dispersal to suitable hibernaculum. Summer drought can dry breeding ponds

before metamorphosis can occur. The egg masses at both Upper Urad and Mizpah (down Clear Creek from Henderson) were killed in 1997 by late spring storms, similar conditions existed in 1996. Breeding sites at higher elevations are more susceptible to negative climatic conditions. In addition, cooler than average summer temperatures slow tadpole development which makes fall conditions critical to timely metamorphosis and dispersal. Water level fluctuation resulting in desiccation of egg masses is also very common. In 1997 and 1998, all egg masses in the main pool at Power Alley desiccated due to the water level dropping prior to hatch. We have been able to mitigate this situation in a number of cases by artificially manipulating water levels or by moving egg masses to stable sites which resulted in substantial recruitment that otherwise would not have occurred.

Variation in yearly recruitment causes natural fluctuations in populations through the absence of sequential year classes. These short-term fluctuations are tempered by the fact that boreal toads are relatively long lived. Long term research is needed to define possible long-term fluctuations and to distinguish between natural and anthropogenic causes of decline (Pechmann et al. 1991).

Habitat Use and Movement

Location data was collected on a total of 26 radio tagged boreal toads (Table 1) which had six or more contacts and was used to calculate movement and habitat use. It should be noted that major heterogeneity between individual toads was observed in both habitat use and movement data. As defined earlier, habitat availability was defined using two spatial scales. First, preference was determined using the entire Upper Urad drainage as available habitat. Next, preference was based on available habitat using a 300 m buffer around the pooled toad locations at each of the three study areas (Figure 2).

Of the 388 toad locations recorded (study areas combined), 34.5% were on 0-20% slope (12.3% of total study area), 23.4% were on 21-40% slope (12.6% of total), 22.4% were on 41-60% slope (28.9% of total), and 19.6% were found on 61-80% slopes (45.2% of total). No toad locations were recorded on slopes >80%; slopes of this magnitude comprised only 0.5% of the study area. The use of all slope categories except 41-60% by boreal toads was significantly out of proportion to availability in the Urad drainage (0-20%, $P < 0.003$; 21-40%, $P < 0.04$; 41-60%, $P < 0.47$; 61-80%, $P < 0.00$). This analysis, using the entire drainage, included more high gradient slope areas (the area was delineated by timberline) which were not used by telemetered toads and therefore not in individual toad's home ranges (Figure 3.). As a result, I feel the slope analysis on a site-specific basis is more meaningful.

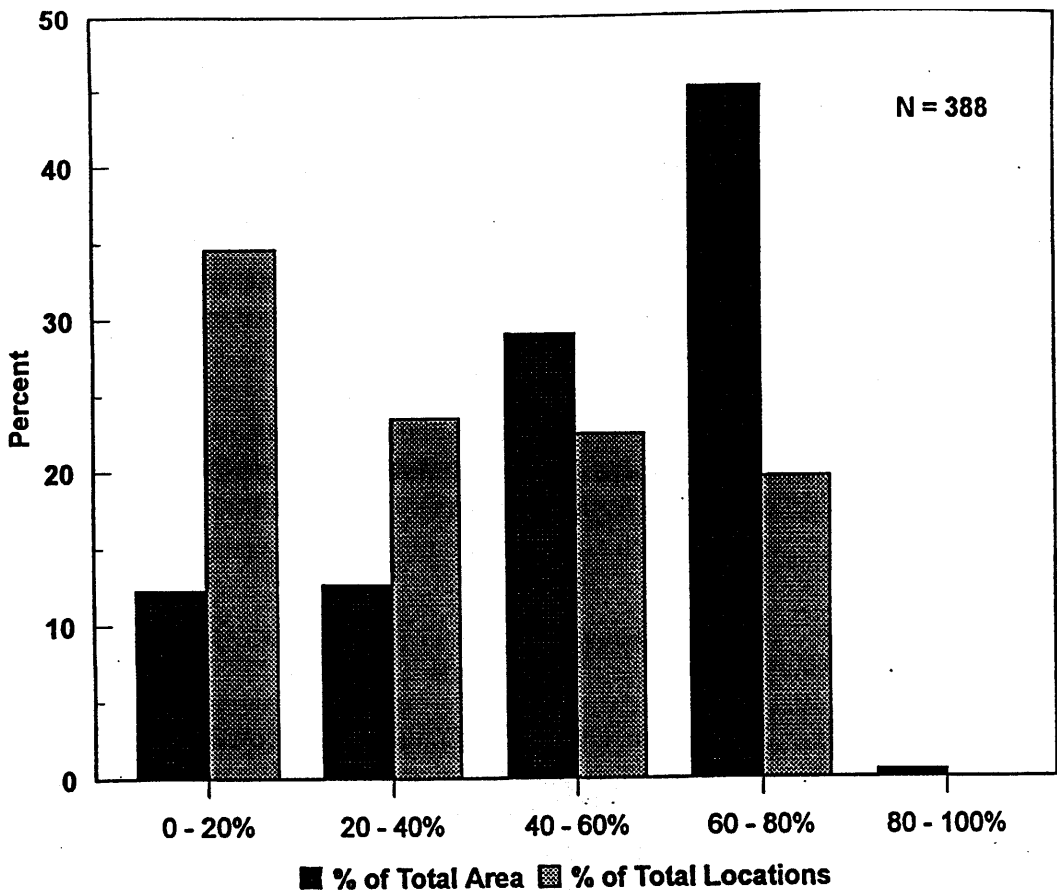

Figure 3. Use of various slope categories in 1998 by boreal toads using the entire Urad valley as available habitat

Of the 136 toad locations in the Donut study area (300 m buffer), 68.4% were on 0-20% slopes (23.2% of total study area), 26.5% were on 21-40% slopes (16.2% of total), 5.2% were on 41-60% slopes (29.7% of total), and 0.0% were on 61-80% slopes (40.0% of total). There were no slopes greater than 80% in the Donut study area. Of the 197 toad locations recorded in the Hesbo study area (300 m buffer), 14.7% were on 0-20% slopes (10.7% of total study area), 23.4% were on 21-40% slopes (20.8% of total), 28.9% were on 41-60% slopes (32.1% of total), and 32.9% were found on 61-80% slopes (36.4% of total). No toad locations were recorded on slopes >80%; slopes of this magnitude comprised only 0.01% of the study area. Of the 55 toad locations in the Urad study area, 21.8% were on 0-20% slopes (15.7% of total study area), 16.4% were on 21-40% slopes (19.5% of total), 41.8% were on 41-60% slopes (36.5% of total), and 20.0% were on 61-80% slopes (28.4% of total). There were no slopes greater than 80% in the Urad study area. When slope data were analyzed on a site-specific basis, boreal toads generally used slopes in proportion to their availability. The only exceptions were 0-20% slopes where use was more than expected ($P < 0.00$) and 40-60% slopes where use was less than expected ($P < 0.02$), based on availability at the Donut site.

The primary objective of this analysis was to show that slope is not a deterrent to toad movement and that boreal toads commonly frequent upland habitats not associated with the relatively flat wetland areas. The use of upland habitats by boreal toads tends to vary depending on the availability of wetland areas in close proximity to the breeding site (Loeffler [ed.] 1998). This can be seen in Figure 4 which shows upland habitats being used extensively after breeding in the Hesbo study area; this site has little wetland areas surrounding the breeding site. In contrast, Figure 5 shows toads in the Donut study area using lower gradient slopes which contain ponds and wetlands relatively close to the breeding site. The Upper Urad study site (Figure 6) contains both wetlands around the breeding site and numerous springs in the upland areas. Bartelt and Peterson (1994) conducted similar radio telemetry studies on the Targhee National Forest in which they quantified use of various habitat components. They found that boreal toads occupied terrestrial habitats 90 percent of the time and their daily movements were significantly influenced by the distribution of suitable cover (usually shrubs). As pointed out by Dodd (1996), these types of data may be helpful in directing attention to the importance of upland habitats in the conservation of amphibian populations which depend upon isolated wetlands for breeding.

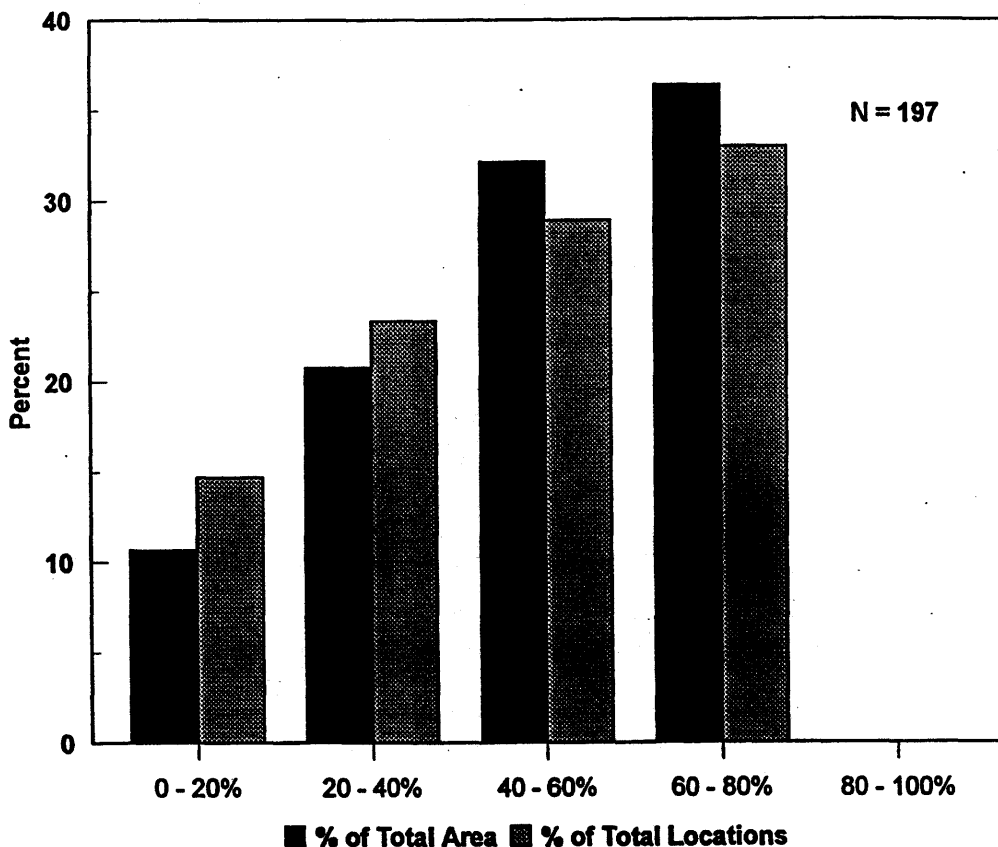

Figure 4. Use of various slope categories in 1998 by boreal toads using a 300 m buffer around the pooled locations in the Hesbo study area as available habitat.

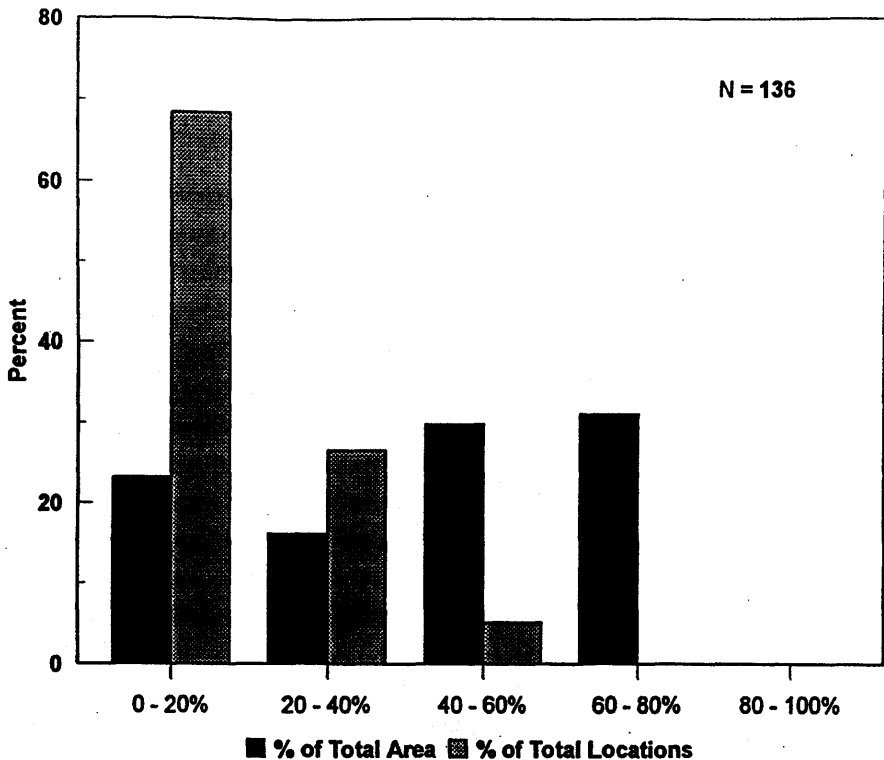

Figure 5. Use of various slope categories in 1998 by boreal toads using a 300 m buffer around the pooled locations in the Donut study area as available habitat.

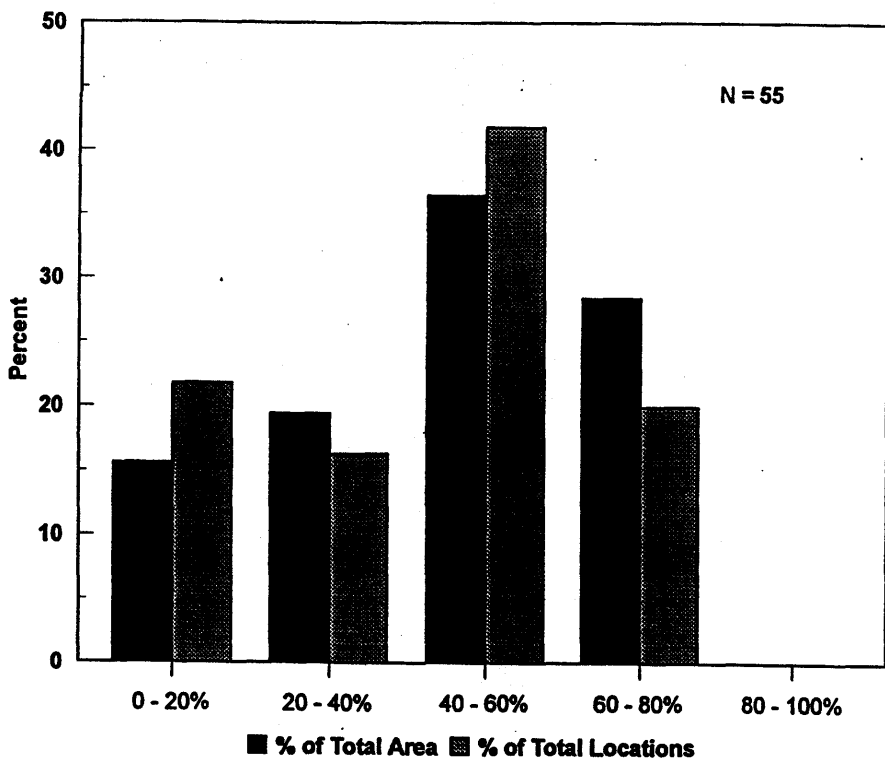

Figure 6. Use of various slope categories in 1998 by boreal toads using a 300 m buffer around the pooled locations in the Urad study area as available habitat.

The habitat areas were defined as conifer/aspens, river, spring seep, lake (lentic water), road, and rock. For the combined study areas (N=388), conifer/aspens contained 10.3% of the toad locations and represented 54.2% of the available habitat showing avoidance of this habitat (P<0.00). The spring seep category contained 3.1% of the toad locations and represented 0.4% of the available habitat; this use was not significantly out of proportion with availability. The lake category had 11.1% of the locations and represented 2.2% of the habitat, showing significant selection (P<0.01). Areas defined as road contained 2.1% of the locations and represented 2.0% of the habitat and therefore were used randomly. Rocky areas were selected for (P<0.00) since they contained 73.5% of the locations and only represented 41.2% of the habitat (Figure 7).

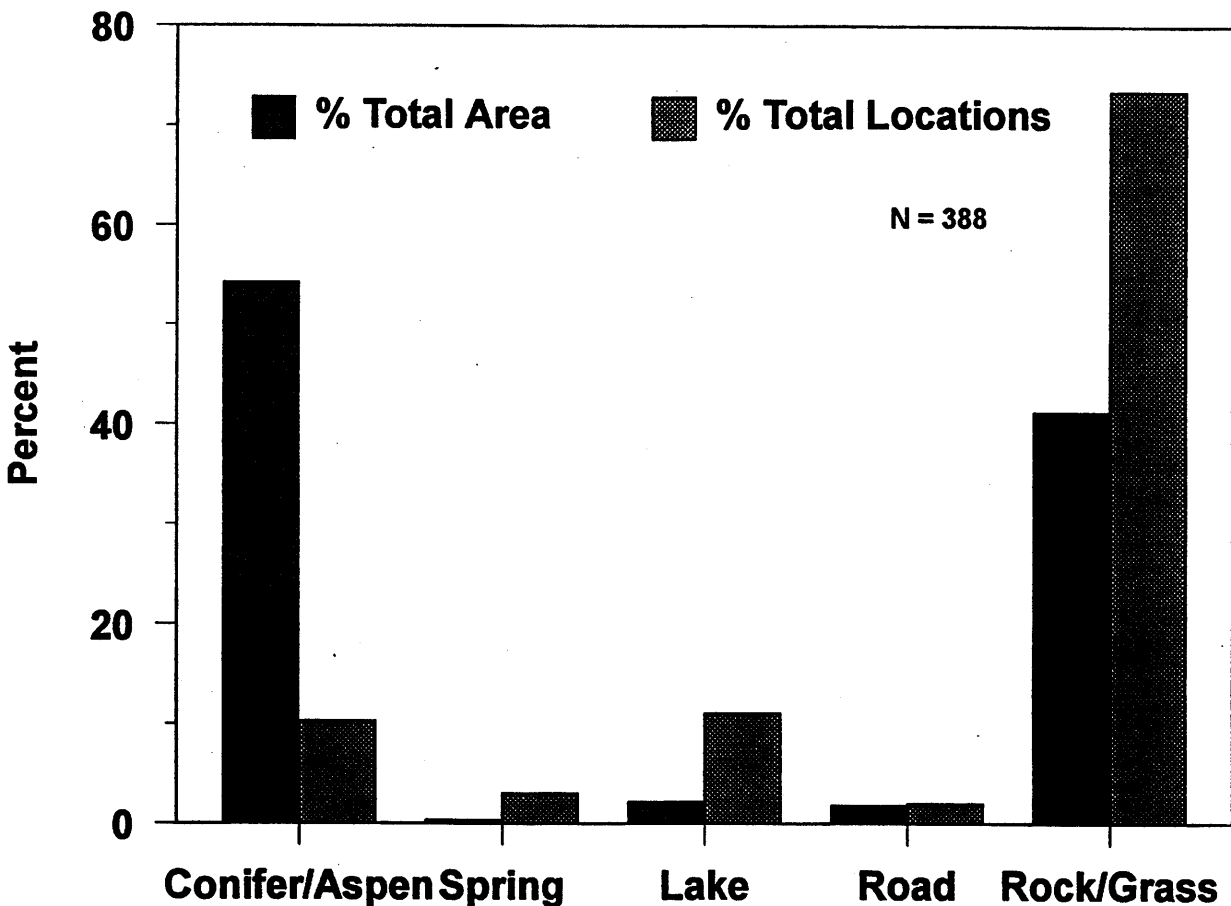

Figure 7. Use of habitat categories in 1998 by boreal toads using the entire Urad valley as available habitat.

Habitat use in each study area was then analyzed separately by defining the available habitat as everything within a 300 m buffer drawn around the pooled toad locations for each site. For the Hesbo study area (N=197), the conifer/aspens category contained 7.1% of the toad locations and represented 65.2% of the available habitat showing avoidance of this habitat (P<0.00). The spring seep category contained 3.1% of the toad locations and represented 1.5% of the available habitat; this use was not significantly out of proportion with availability. The lake category had 17.3% of the locations and represented 5.5% of the habitat, showing significant selection (P<0.03). Areas defined as road contained 2.0% of the locations and represented 2.5% of the habitat and therefore this category was used randomly. Rocky areas were selected for (P<0.00) since they contained 70.6% of the locations and only represented 24.9% of the habitat (Figure 8). It should be noted, however, that the majority of the rocky areas in the Hesbo study site were actually rock outcroppings within the upland conifer/aspens habitat type.

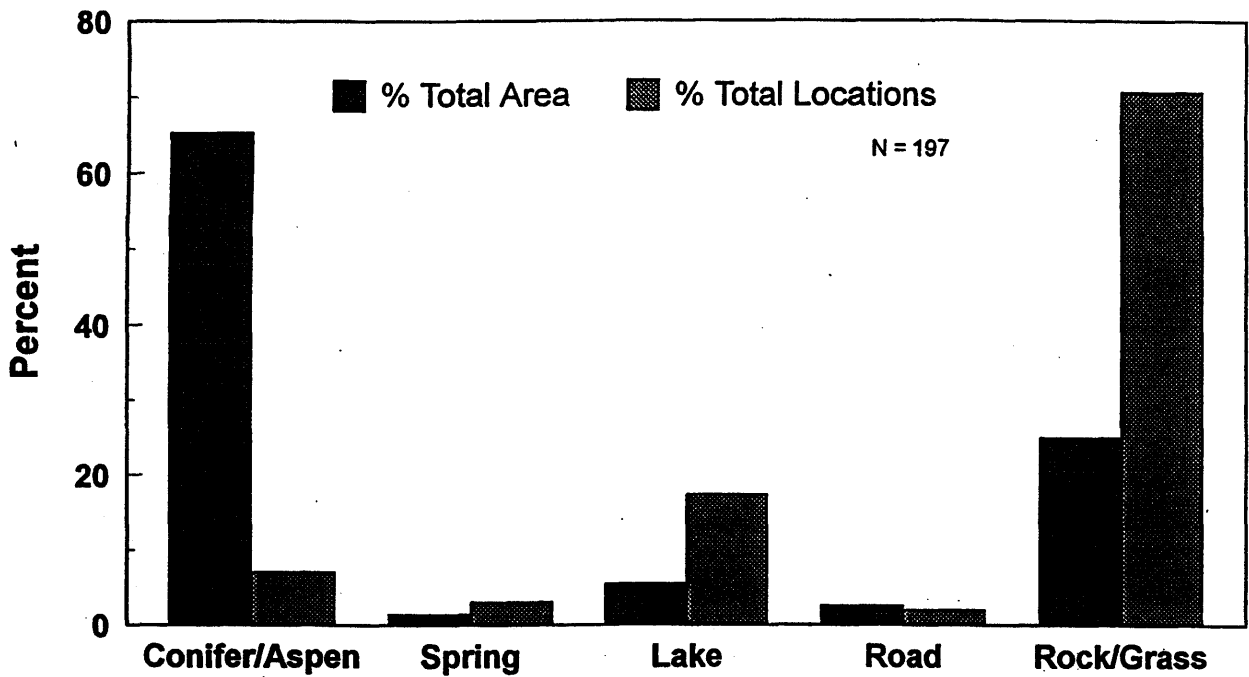

Figure 8. Use of habitat categories in 1998 by boreal toads using a 300 m buffer around the pooled locations in the Hesbo study area as available habitat.

For the Donut study area (N=136), the conifer/aspen category contained 17.7% of the toad locations and represented 43.9% of the available habitat showing avoidance of this habitat (P<0.00). The spring seep category contained 4.4% of the toad locations and represented 0.1% of the available habitat; this use was not significantly out of proportion with availability. The lake category had 6.2% of the locations and represented 2.9% of the habitat and therefore was used randomly. Areas defined as road contained 2.9% of the locations and represented 4.2% of the habitat and therefore this category was used in proportion to availability. Rocky areas were selected for (P<0.01) since they contained 68.4% of the locations and only represented 48.8% of the habitat (Figure 9).

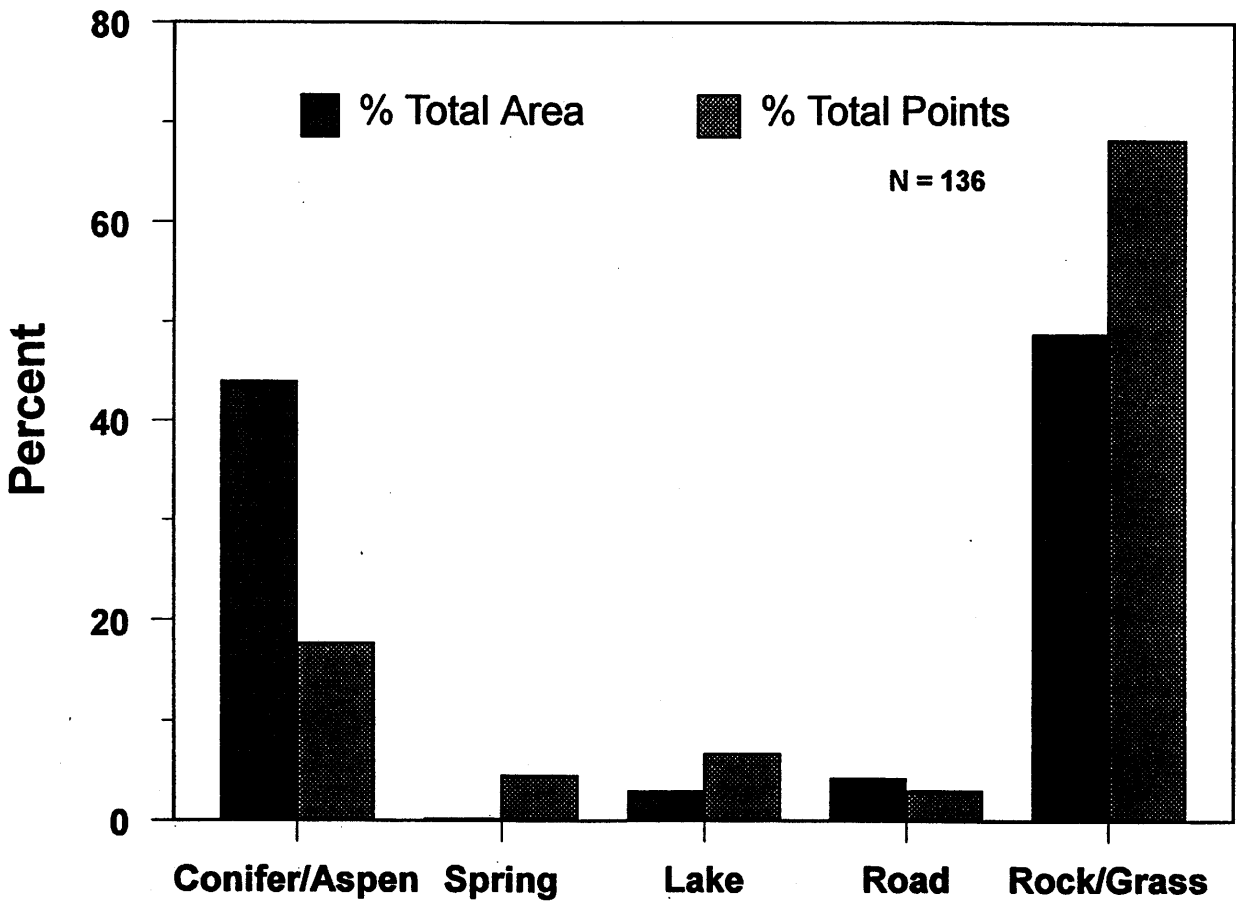

Figure 9. Use of habitat categories in 1998 by boreal toads using a 300 m buffer around the pooled locations in the Donut study area as available habitat.

The only habitat categories used in the Urad study area were aspen/conifer and rocky areas, although all other habitat types were present. The conifer/aspen category contained 3.6% of the toad locations but represented 60.5% of available habitat, showing significant ($P < 0.00$) under-utilization of this habitat. Rocky areas contained 96.4% of the total toad locations but only represented 34.1% of the available habitat showing significant ($P < 0.00$) selection for these areas (Figure 10). It should be noted that rocky areas in the Upper Urad study were found both around the breeding site and as rock outcroppings in upland aspen/conifer areas.

Our data shows that toads do indeed use a wide variety of habitat types and there was high variability between individuals in habitat selection. The activity and subsequent use of habitats by ectotherms is closely tied to their body temperatures (Huey 1991) which may explain the disproportionately high use of rocky areas. Toads were commonly found basking in rocky areas, but they were always within a couple of meters of a burrow or vegetative shelter.

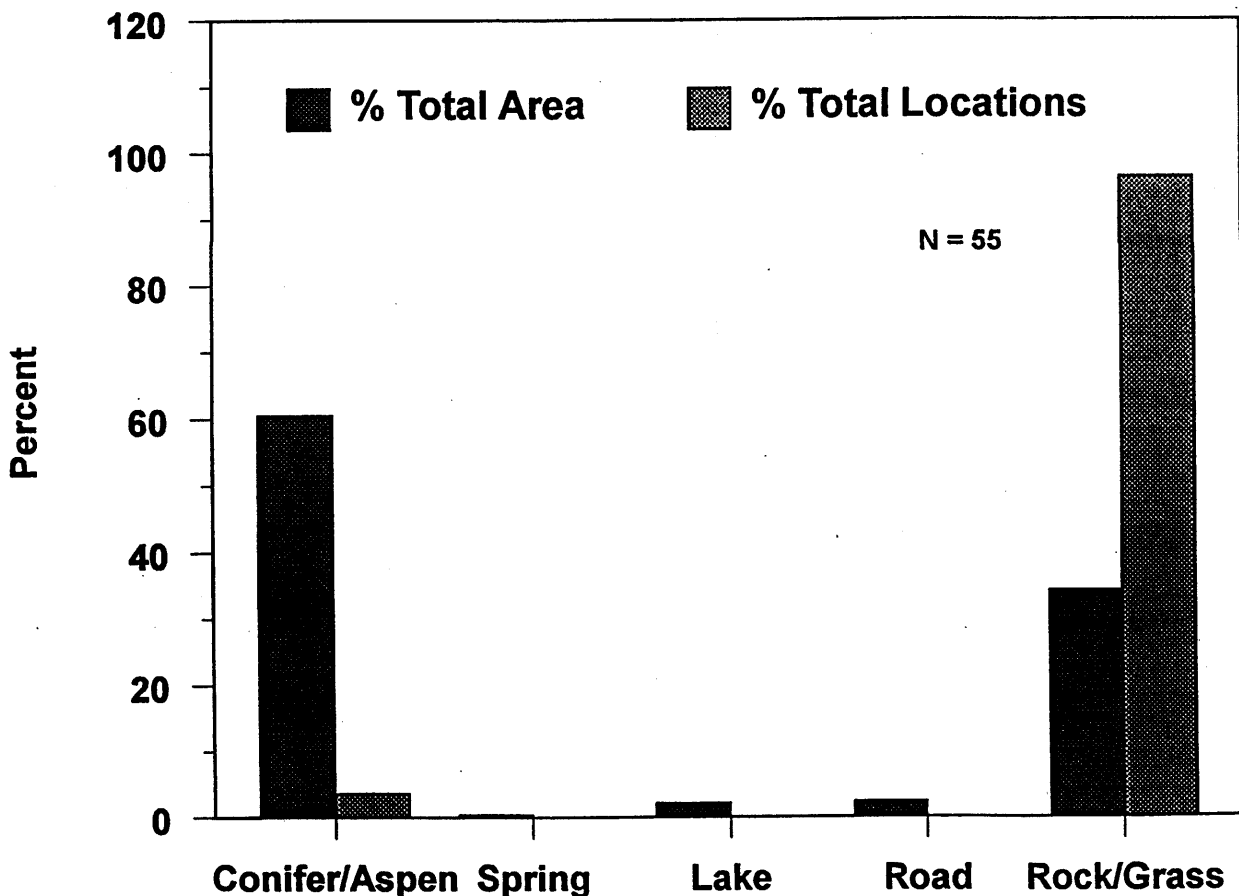

Figure 10. Use of habitat categories in 1998 by boreal toads using a 300 m buffer around the pooled locations in the Urad study area as available habitat.

Movement was calculated for each toad weekly on a 3 m² digital elevation model in ARC/INFO as previously described. Three hundred thirty four individual weekly movement measurements were calculated for 33 toads. The average distance moved per day for all telemetered toads was 8.9 m (SD=135.0). Male toads moved an average of 14.1 m per day (SD=67.1, N=11) and females moved an average of 6.3 m per day (SD=14.3, N=22). There was greater variability between the average daily movement increments of males than females, Figure 11. The minimum average distance moved per day was 0.06 m by a female, which was tracked for 90 days, and the maximum average daily movement was 767.0 m by a male monitored for a total of 70 days. The maximum distance traveled by any telemetered toad during the summer of 1998 was 1,397.6 m by a female monitored 112 days. Due to individual heterogeneity, it could not be shown that daily movement by female boreal toads was significantly different than males (Z=-0.4874, P=0.626).

Boreal toad movement patterns are highly variable between individuals. Female toads which we radio tagged at a breeding site left the location immediately after egg deposition and generally moved further away from the breeding site quicker than did males. Again habitat use heterogeneity among females was observed with some finding suitable summer locations within 400 to 600 m from the breeding wetland while other individuals moved further into upland habitats.

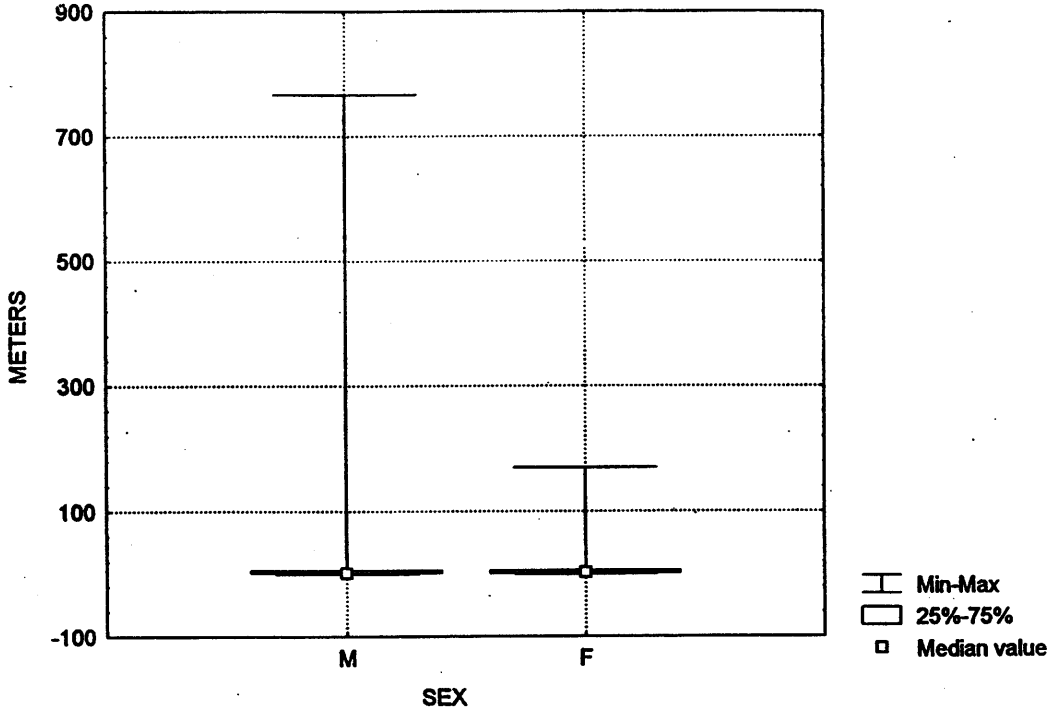

Figure 11. Comparison of male and female boreal toad daily movement increments (male=113, female=205) at the Henderson/Urad study site in 1998.

Home Range Estimates

As with movement, there were major differences (heterogeneity) between individual toad home range sizes. As expected, the adaptive kernel method (AK) provides larger estimates than minimum convex polygon (MCP). We can probably assume that we are missing movements when we only locate individuals once per week. Therefore, I feel that the AK method is probably more useful in terms of recommending construction setbacks or designating critical habitat. The mean home range area in 1998 for telemetered boreal toads in the Henderson population was 46,185 m² (min.=1,893, max.=474,000, SD=121,710) using the AK method and 23,894 m² (min.= 461, max.=240,700, SD=56,960) with the MCP (Table 2). The mean area used by males was 72,869 m² using the AK method and 37,122 m² using the MCP approach. The mean area used by females was 34,325 m² using the AK method and 18,015 m² using the MCP approach (Figure 12). The mean home range area excluding the breeding site was 43,558 m² (min.=379, max.=474,100, SD=124,847) when using the AK method and 22,806 m² (min.= 101, max.=240,700, SD=58,413) with the MCP. The mean area used by males was 70,296 m² using the AK method and 36,131 m² using the MCP approach. The mean area used by females was 31,675 m² using the AK method and 16,884 m² using the MCP approach. Cumulative home range estimates were also calculated for all telemetered toads at each site for 1997 and 1998 (Table 3).

Although home range size was not significantly different between sexes using either method at $\alpha=0.05$ ($Z=-1.61$, $P=0.11$ for AK; $Z=-2.06$, $P=0.08$ for MCP) as a result of high variability, I feel there are some general tendencies which warrant discussion. In general, females move further from the breeding site after breeding (possibly because they do not return to breed each year) and set up a fairly discreet home range. In general, males don't go as far from their breeding site (possibly because they return each year) but may move around quite a bit, which increases their home range size. Males often return to the breeding site or other wetland in the vicinity several times during the summer and then return to upland habitats. Females seem to be more inclined to take up residence in an upland area which contains a spring or wet area and seldom return to the breeding area during the summer. The same toads (both sexes) were observed repeatedly in different areas in the same burrows or general areas they were previously recorded at, i.e. the toads would move to a different area 10 to 50 meters away and then return to the same exact place a week or two later. Other authors have also noted distinct home range areas in anuran populations (Brattstrom 1962; Campbell 1976; Parker and Gittins 1979; Bartelt and Peterson 1994). Plots of the calculated home ranges for each toad may be found in Appendix 2.

Table 2. Home range estimates for radio telemetered toads in the Henderson Mine area in 1998.

Year	Site	Tag Number	Sex	Locations	Adaptive Kernel (m ²)	Minimum Convex Polygon (m ²)	LSCV Score
1998	Donut	386	F	13	8158	10730	-638500
1998	Urad	476	F	14	10310.00	3829.00	-25209.00
1998	Urad	487	F	8	3629	554	-3344.6
1998	Urad	490	F	11	10460	1768	-20998
1998	Hesbo	572	F	22	2473.00	620.70	-108980.00
1998	Hesbo	574	F	23	15500.00	8916.00	-1069300.00
1998	Hesbo	576	F	10	7826.00	1383.00	-227720.00
1998	Hesbo	577	F	11	11990.00	7444.00	-832840.00
1998	Urad	578	F	12	10160.00	15450.00	-975960.00
1998	Hesbo	579	F	22	4384.00	460.80	-342640.00
1998	Hesbo	580	F	20	12460.00	6659.00	-292150.00
1998	Hesbo	581	F	10	14130.00	9275.00	-2696300.00
1998	Hesbo	582	F	8	7533.00	8068.00	-302510.00
1998	Hesbo	583	F	19	11140.00	3593.00	-378940.00
1998	Donut/Urad	588	F	17	474100.00	240700.00	-43008500.00
1998	Donut	590	F	7	2387.00	802.00	-2077.40
1998	Hesbo	771	F	6	4988.00	828.90	-16287.00
1998	Hesbo	773	F	10	6229.00	3182.00	-45520.00
1998	Donut	350	M	15	2628	630.7	-5244.8
1998	Hesbo	471	M	10	1893.00	538.60	-588.54
1998	Hesbo	482	M	14	31070	35190	-1940500
1998	Donut	585	M	18	36310.00	28400.00	-11331000.00
1998	Hesbo/Donut	587	M	11	459500.00	195000.00	-10066000.00
1998	Donut	589	M	18	20040.00	13560.00	-303660.00
1998	Donut	592	M	18	19350.00	12420.00	-1792100.00
1998	Donut	919	M	17	12160.00	11240.00	-1141300.00
Mean					46184.92	23893.95	
Home							
Range							
Mean					72868.88	37122.41	
Male							
Mean					34325.39	18014.63	
Female							

Table 3. Cumulative boreal toad home range estimates by site from the Henderson study area.

Year	Site	Tag Number	Sex	Locations	Adaptive Kernel (m ²)	Minimum Convex Polygon (m ²)	LSCV Score
1998	Hesbo	all* from Hesbo	All	185	128700	98360	-16099000
1998	Donut	All	All	84	78750	25230	-1413800
1998	Upper Urad	All	All	43	62660	34570	-378510
1997	Hesbo	all	All	114	71940	44570	-18203000
1997	Donut/Ann's Pond	915 and 919		23	32350	15000	-626370
Mean					74880	43546	

* Excludes toad 587

Boreal Toad Home Ranges 1998

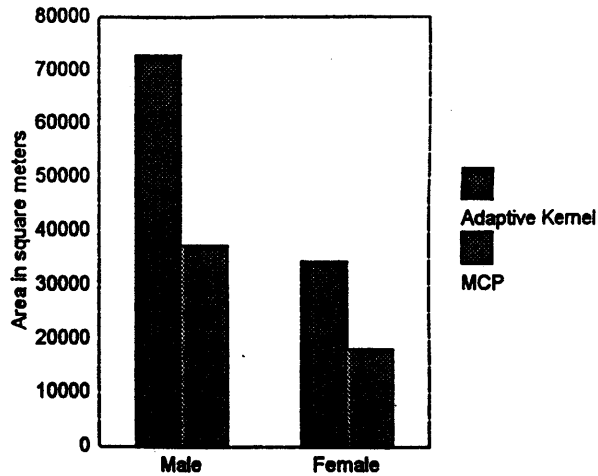

Figure 12. Comparison of home range sizes for male and female telemetered toads at the Henderson Mine in 1998.

Breeding Site Population Estimates

Boreal toads at the Urad/Henderson breeding sites were PIT tagged during 1995 to 1998 breeding site monitoring activities. Monitoring begins in mid-May and continues until no new individuals are found at each site. Males typically persist at the breeding site for several weeks after breeding activity ceases. As stated in methods, the program Capture (White et al. 1982) was used to estimate the number of males at each site for each year monitored.

Listed below is a brief description of each possible model selection, see White et al. 1982 for complete descriptions.

Model M_0 : Population estimation with constant probability of capture.

Model M_h : Population estimation with variable probability of capture by animal.

Model M_b : Population estimation with behavioral response to capture.

Model M_{bh} : Population estimation with behavioral response and heterogeneity.

Model M_t : Population estimation with time specific changes in probability of capture.

Model M_{th} : Population estimate under time variation and individual heterogeneity in capture probabilities.

Model M_{tb} : Population estimation under time variation and behavioral response to capture.

Model M_{tbh} : Population estimate under time variation, behavioral response, and heterogeneity.

Table 4. Population estimates for male boreal toads at the breeding sites in the Urad/Henderson area from 1995 to 1998.

Site	Year	Model	Estimate	SE	95% CI
Hesbo	1995	M _{bh}	141	1.57	141 to 148
Hesbo	1996	M _b	119	4.79	114 to 134
Hesbo	1997	M _t	120	2.52	117 to 127
Hesbo	1998	M _t	120	2.73	117 to 128
2 Pond	1995	M _t	32	0.95	32 to 36
2 Pond	1996	M _o	6	0.91	4 to 8
Power Alley	1996	M _{th}	61	6.72	54 to 82
Power Alley	1997	M _{tb}	80	5.10	80 to 113
Power Alley	1998	M _{tb}	80	0.66	80 to 80
Upper Urad	1996	M _{tb}	41	0.26	40 to 41
Upper Urad	1997	M _o	34	7.59	27 to 59
Upper Urad	1998	M _h	29	5.27	23 to 44
Donut	1997	M _{th}	19	4.32	16 to 37
Donut	1998	M _t	44	6.29	37 to 63
Anne's Pond	1998	M _b	33	0.44	33 to 33

In all cases, the estimate derived from the Capture model (Table 4) was nearly the same as the total number handled at each site indicating we had PIT tagged and handled close to the entire breeding population of males each year at each site. Based on the 1996 estimates, the male breeding population in the Henderson/Urad metapopulation was approximately 227, in 1997, 233, and 306 in 1998. This type of work is critical in defining what is natural fluctuation in breeding numbers over time and identifying declines.

As stated earlier, the number of female boreal toads in the Henderson/Urad area is difficult to estimate because they were never recaptured again in the same year, and only rarely in subsequent years. From 1995 to 1998, the only site with female recaptures was Hesbo. There was one female tagged in 1995 that returned in 1996, one tagged in 1996 that returned in 1997, and in 1998 there was one recapture from 1996 and one from 1997. No females that were tagged at one site ever showed up at a different site. This is fairly conclusive evidence that females rarely breed every year. There is also evidence that male:female capture rates are skewed toward male dominance (Campbell 1976). If you were to assume that every female that frequented a breeding site left an egg mass, which is probably a reasonable assumption, ten or eleven females visited the

Hesbo site in 1997, nine of these were found during breeding site monitoring. In 1998, 18 females were handled during monitoring and 18 egg masses were found which indicates we are seeing most of the females visiting the site each year. From 1995 to 1998 a total of 72 individual females (all years and all sites combined) were handled in comparison to 221 males in 1995, 223 males in 1996, 209 males in 1997, and 306 males in 1998 (all sites combined). The yearly male:female sex ratios were 20:1 in 1995, 32:1 in 1996, 10:1 in 1997, and 8:1 in 1998 which again supports the hypothesis that females do not breed every year. More research needs to be conducted on the biology and population dynamics of female boreal toads as this information may be a key link in population declines. Trends in population size and breeding success at all known boreal toad breeding sites is being monitored on an ongoing basis. This information will permit rapid identification of changes in abundance, which could influence recovery. It is obvious not all sites recruit every year and this fluctuation is natural. In most cases, individual breeding sites recruit in one out of three years at best.

REFERENCES

- Bartelt, P. E. and C. R. Peterson. 1994. Riparian habitat utilization by western toads (*Bufo boreas*) and spotted frogs (*Rana pretiosa*) on the Targee National Forest. USDA Forest Service Contract #INT-93780-CCSA Final Report. 30 p. plus figures.
- Brattrom, B. H. 1962. Homing in the giant toad, *Bufo marinus*. *Herpetologica*. 18:176-180.
- Campbell, J. B. 1976. Environmental controls on boreal toad populations in the San Juan Mountains. Pp. 289-295 in *Ecological impacts of snowpack augmentation in the San Juan Mountains, Colorado*. Steinhoff, H. W., and J. D. Ives (eds.). Final Report San Juan Ecology Project, Colorado State University Publ., Fort Collins.
- ESRI (Environmental Systems Research Institute). 1997. ARC/INFO 7.1.2. Redlands, CA.
- Huey, R. B. 1991. Physiological consequences of habitat selection. *American Midland Naturalist*. 137:91-115.
- Jones, M. S., J. P. Goettl, and L. J. Livo. in press. *Bufo boreas* (boreal toad) Predation. *Herpetological Review*.
- Kie, J.G., J.S. Baldwin, and C.J. Evans. 1994. CALHOME electronic user's manual. U.S. Forest Service, Pacific Southwest Research Station, 2081 East Sierra Avenue, Fresno, CA 93710.
- Parker, A. G. and S. P. Gittins. 1997. A note on home range in the common toad in Mid-Wales and a method for tracking toads for behavioral observation. *British Journal of Herpetology* 6:7-8.
- Pechmann, J. H. K., D. E. Scott, R. D. Semlitsch, J. P. Caldwell, L. J. Vitt, and J. W. Gibbons. 1991. Declining amphibian populations: The problem of separating human impacts from natural fluctuations. *Science* 252:892-895.
- Samuel, M.D. and E.O. Garton. 1985. Home range: a weighted normal estimate and tests of underlying assumptions. *J. Wildl. Manage.* 49:513-519.
- SAS Institute, 1994, SAS users manual update for release 6.10. SAS Institute, Cary, North Carolina.
- White, C.W. and R.A. Garrott. 1990. Analysis of wildlife radio-tracking data. Academic Press Inc, San Diego, CA. 383 pp.







White, G. C., D. R. Anderson, K. P. Burnham, and D. L. Otis. 1982. Capture-recapture and removal methods for sampling closed populations. Los Alamos National Laboratory, Los Alamos.

Worton, B.J. 1989. Kernel methods for estimating the utilization distribution in home-range studies. *Ecology*. 70:164-168.

APPENDIX 1.

**Boreal toad radio telemetry contact locations
in the Henderson/Urad study area, 1998.**

Legend

-  Lake or pond
 -  Conifer/Aspen forest
 -  Unimproved road
 -  Stream
 -  Spring
 -  Boreal toad location
 -  Hibernaculum
- Other areas consist of
rock base/grass interspersion

Scale = 1:5,500
Meters







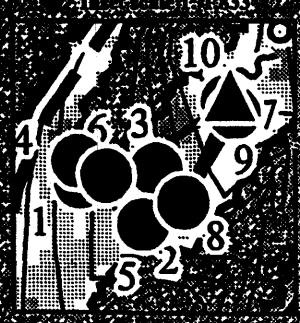

Toad 471

#	Date
1	7/28/98
2	8/4/98
3	8/11/98
4	8/18/98
5	8/25/98
6	9/1/98
7	9/8/98
8	9/15/98
9	9/22/98
10	9/29/98



Legend

-  Lake or pond
 -  Conifer/Aspen forest
 -  Unimproved road
 -  Stream
 -  Spring
 -  Boreal toad location
 -  Hibernaculum
- Other areas consist of
rock base/grass interspersion

Scale = 1:5,500
Meters







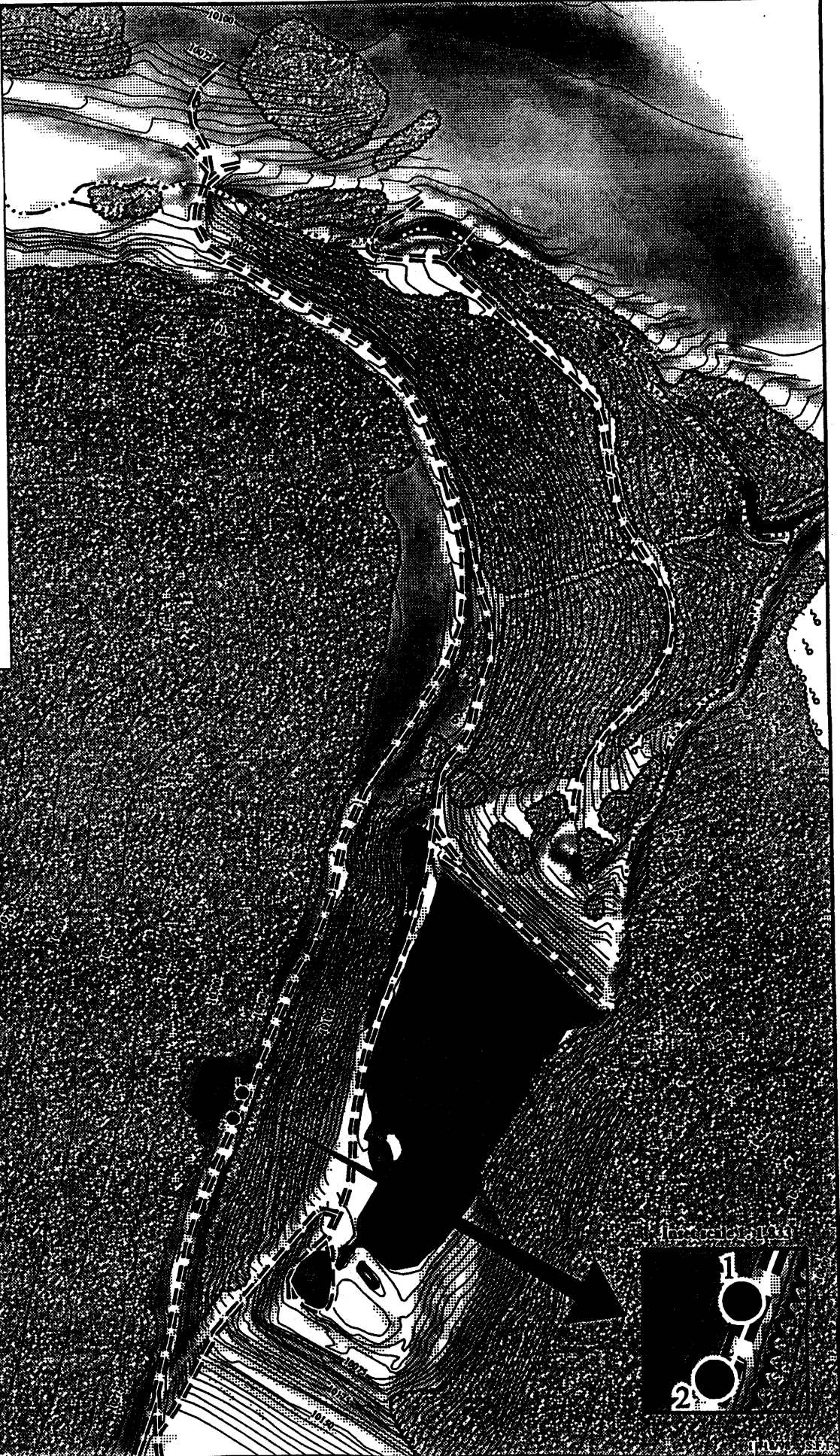

Toad 477

Date

1	7/22/98
2	7/28/98



Legend

-  Lake or pond
 -  Conifer/Aspen forest
 -  Unimproved road
 -  Stream
 -  Spring
 -  Boreal toad location
 -  Hibernaculum
- Other areas consist of
rock base/grass interspersions

Scale = 1:5,500
Meters









Toad 482

#	Date
1	6/30/98
2	7/01/98
3	7/08/98
4	7/21/98
5	7/28/98
6	8/04/98
7	8/11/98
8	8/18/98
9	8/25/98
10	9/01/98
11	9/08/98
12	9/15/98
13	9/22/98
14	9/29/98

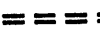

Legend

-  Lake or pond
 -  Conifer/Aspen forest
 -  Unimproved road
 -  Stream
 -  Spring
 -  Boreal toad location
 -  Hibernaculum
- Other areas consist of
rock base/grass interspersion

Scale = 1:5,500
Meters







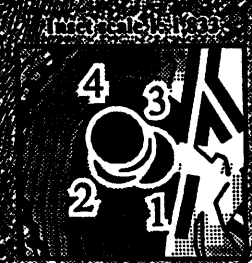

Toad 571

#	Date
1	6/23/98
2	7/01/98
3	7/07/98
4	7/13/98



Legend

-  Lake or pond
 -  Conifer/Aspen forest
 -  Unimproved road
 -  Stream
 -  Spring
 -  Boreal toad location
 -  Hibernaculum
- Other areas consist of
rock base/grass interspersion

Scale = 1:5,500
Meters







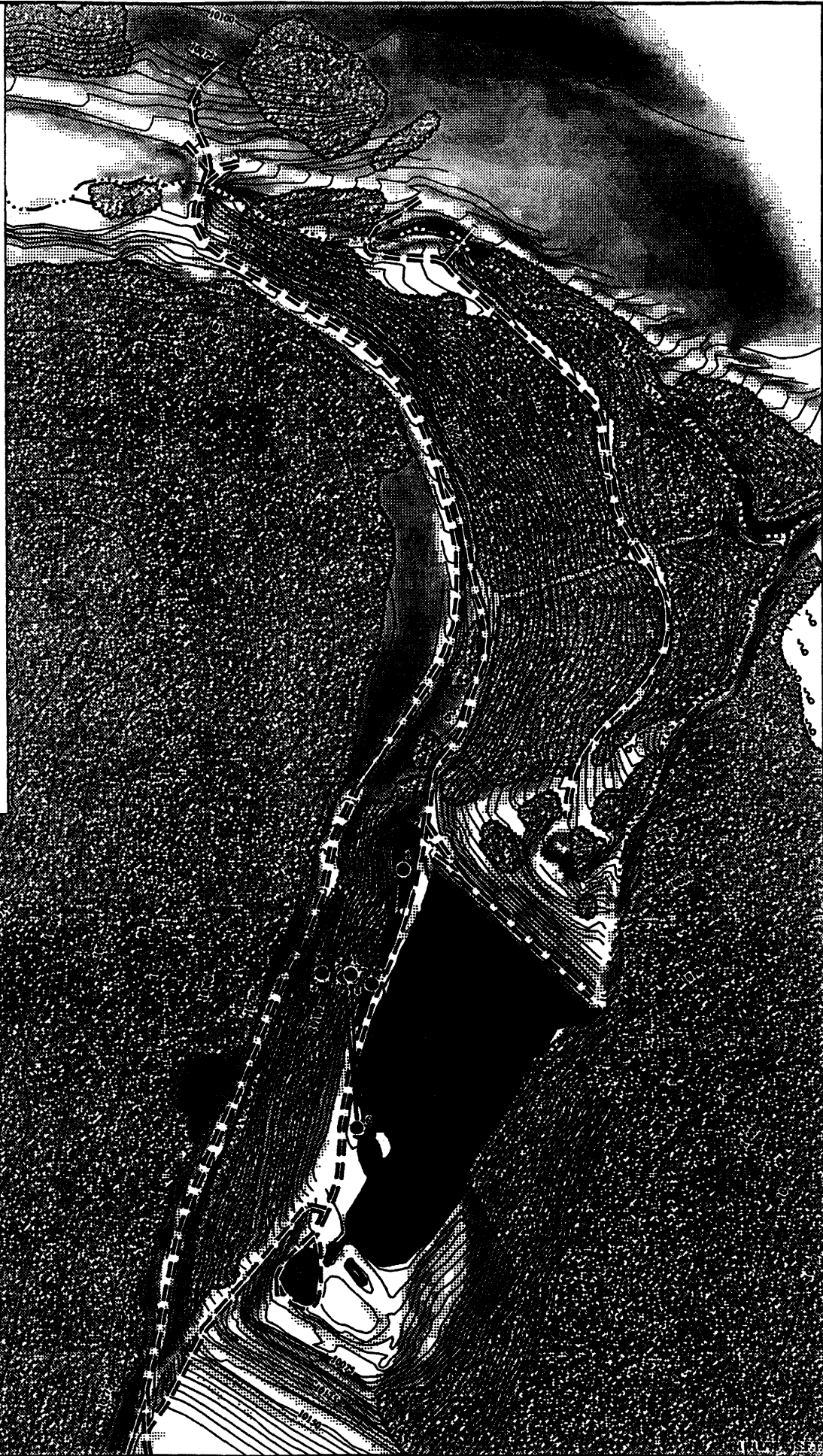

Toad 577

Date

1	5/15/98
2	5/19/98
3	5/27/98
4	6/04/98
5	6/09/98
6	6/16/98
7	6/23/98
8	7/01/98
9	7/08/98
10	7/13/98
11	7/21/98

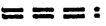

Legend

-  Lake or pond
 -  Conifer/Aspen forest
 -  Unimproved road
 -  Stream
 -  Spring
 -  Boreal toad location
 -  Hibernaculum
- Other areas consist of
rock base/grass interspersion

Scale = 1:5,500
Meters







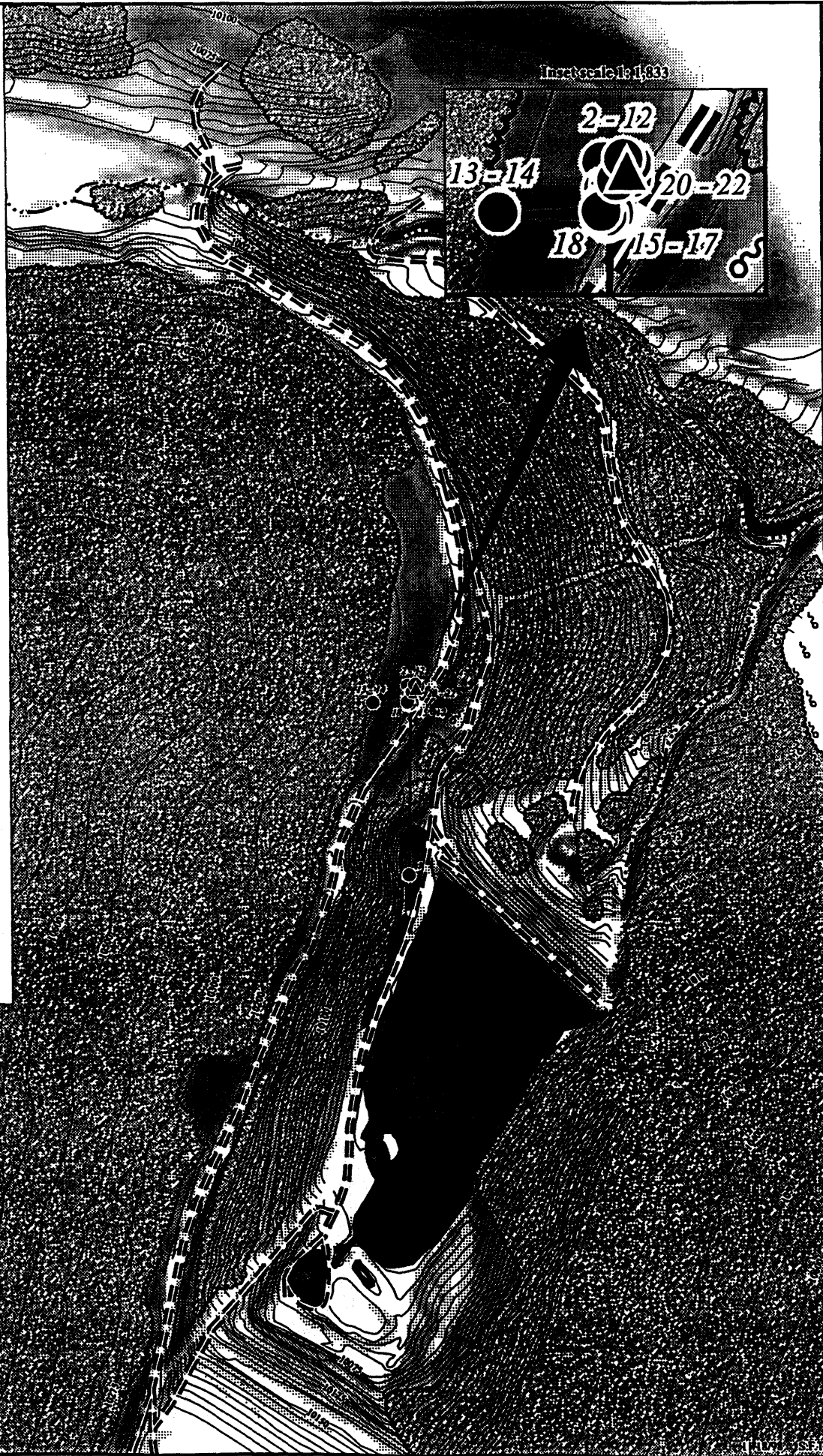

Toad 579

Date

1	5/15/98
2	5/18/98
3	5/19/98
4	5/27/98
5	6/02/98
6	6/09/98
7	6/16/98
8	6/23/98
9	7/01/98
10	7/07/98
11	7/13/98
12	7/21/98
13	7/28/98
14	8/05/98
15	8/11/98
16	8/18/98
17	8/25/98
18	9/01/98
19	9/08/98
20	9/15/98
21	9/22/98
22	10/6/98



Legend

-  Lake or pond
 -  Conifer/Aspen forest
 -  Unimproved road
 -  Stream
 -  Spring
 -  Boreal toad location
 -  Hibernaculum
- Other areas consist of
rock base/grass interspersion

Scale = 1:5,500
Meters

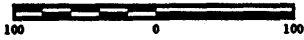





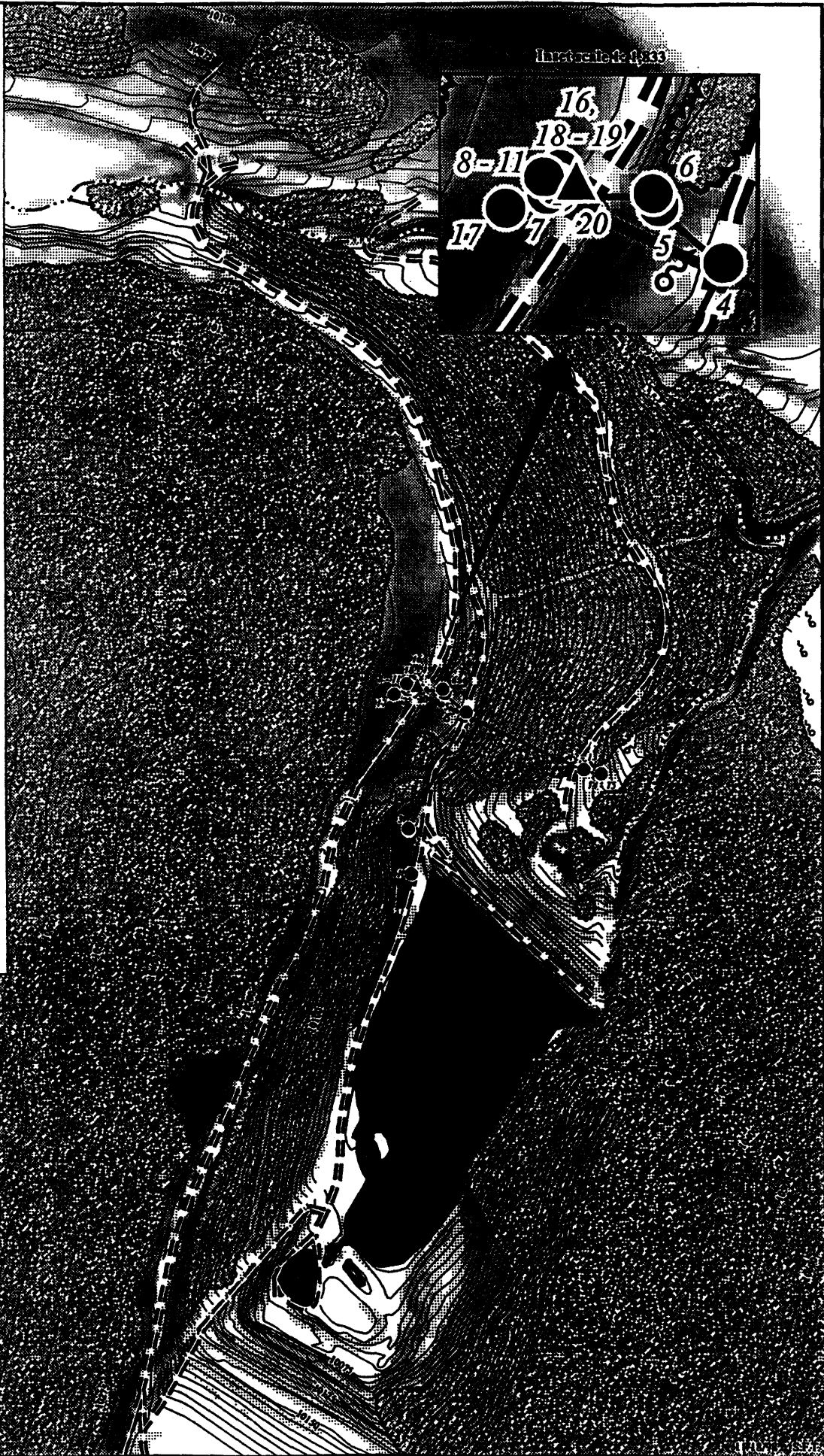

Toad 580

#	Date
1	5/15/98
2	5/18/98
3	5/19/98
4	5/27/98
5	6/02/98
6	6/09/98
7	6/16/98
8	6/23/98
9	7/01/98
10	7/07/98
11	7/13/98
12	7/21/98
13	8/04/98
14	8/11/98
15	8/18/98
16	8/25/98
17	9/01/98
18	9/08/98
19	9/22/98
20	9/29/98

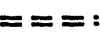

Legend

-  Lake or pond
 -  Conifer/Aspen forest
 -  Unimproved road
 -  Stream
 -  Spring
 -  Boreal toad location
 -  Hibernaculum
- Other areas consist of
rock base/grass interspersed

Scale = 1:5,500
Meters









Toad 581

#	Date
1	5/15/98
2	5/18/98
3	5/19/98
4	5/27/98
5	6/02/98
6	6/09/98
7	6/16/98
8	6/23/98
9	7/01/98
10	7/07/98

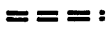

Legend

-  Lake or pond
-  Conifer/Aspen forest
-  Unimproved road
-  Stream
-  Spring
-  Boreal toad location
-  Hibernaculum
- Other areas consist of rock base/grass interspersion

Scale = 1:5,500
Meters

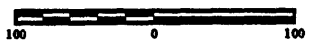





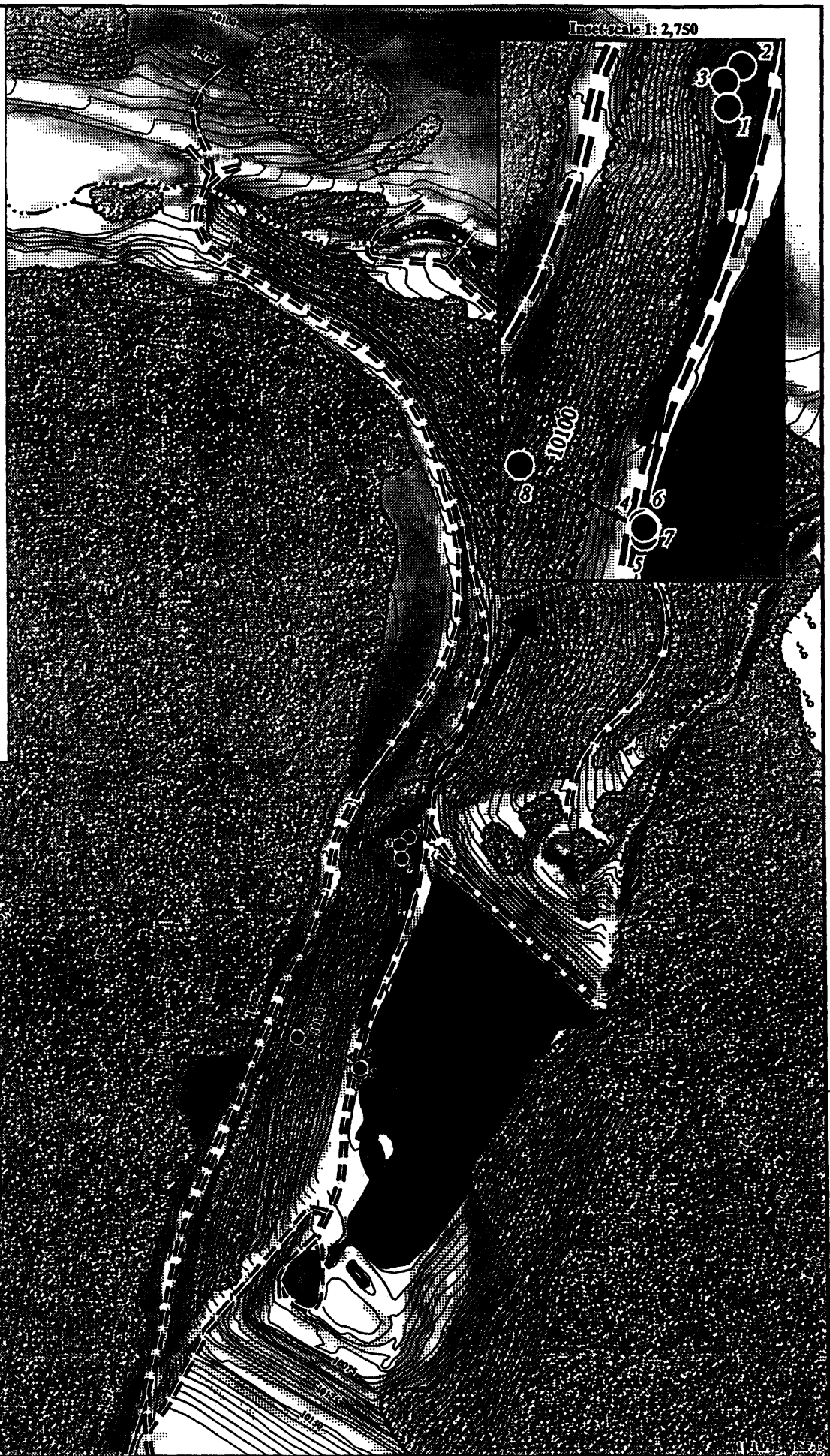

Toad 582

#	Date
1	5/15/98
2	5/18/98
3	5/19/98
4	5/27/98
5	6/09/98
6	6/16/98
7	6/23/98
8	7/13/98



Legend

-  Lake or pond
 -  Conifer/Aspen forest
 -  Unimproved road
 -  Stream
 -  Spring
 -  Boreal toad location
 -  Hibernaculum
- Other areas consist of
rock base/grass interspersion

Scale = 1:5,500
Meters



Toad 583







Date

1	5/18/98
2	5/19/98
3	5/27/98
4	6/02/98
5	6/09/98
6	6/16/98
7	6/23/98
8	7/01/98
9	7/07/98
10	7/13/98
11	7/28/98
12	8/04/98
13	8/11/98
14	8/18/98
15	9/01/98
16	9/08/98
17	9/15/98
18	9/22/98
19	9/29/98



Inset scale 1:1,833

Legend

-  Lake or pond
 -  Conifer/Aspen forest
 -  Unimproved road
 -  Stream
 -  Spring
 -  Boreal toad location
 -  Hibernaculum
- Other areas consist of
rock base/grass interspersions

Scale = 1:5,500
Meters

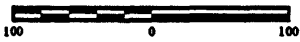





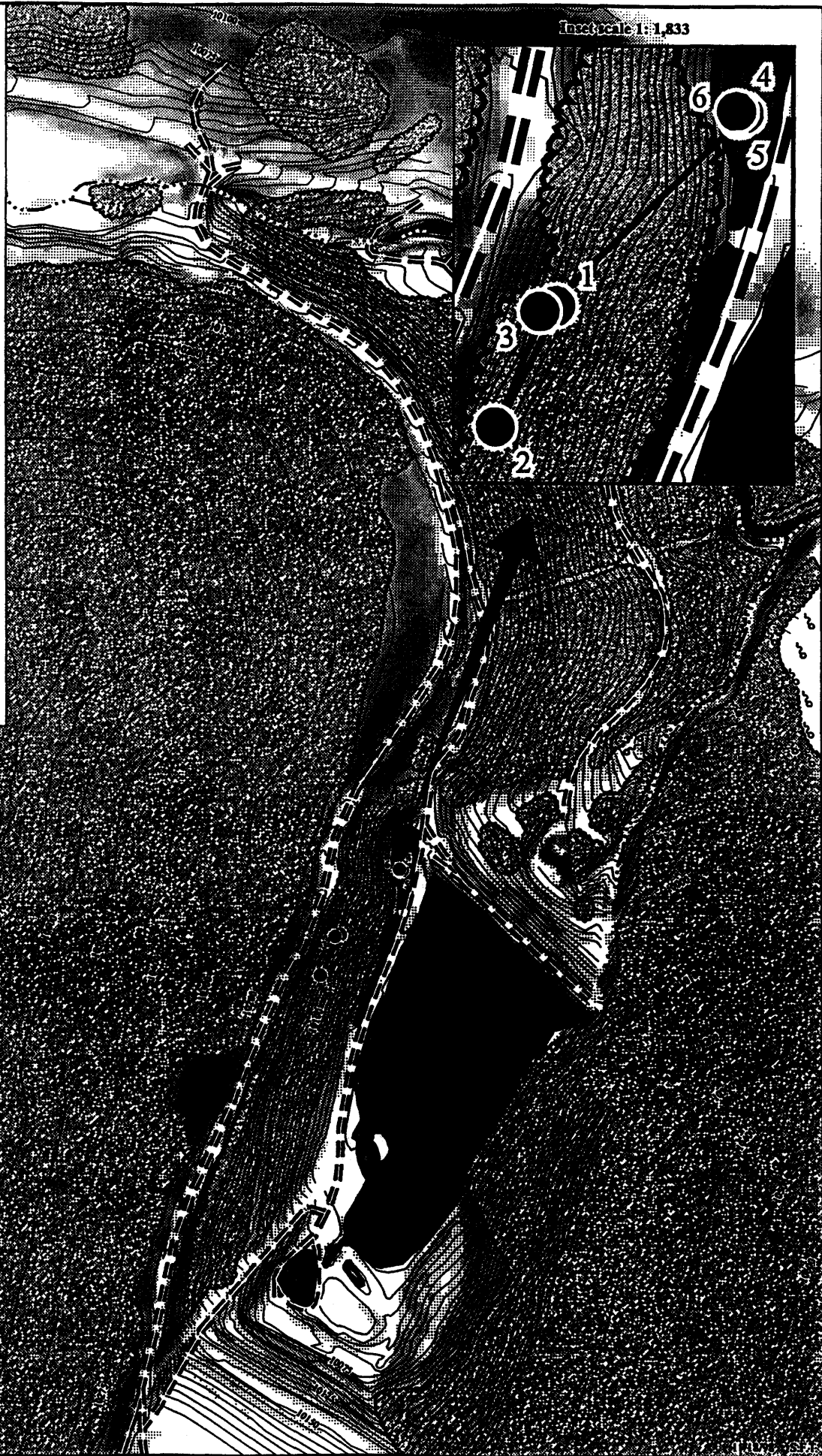

Toad 771

Date

1	5/15/98
2	5/18/98
3	5/19/98
4	5/27/98
5	6/02/98
6	6/09/98



Legend

-  Lake or pond
-  Conifer/Aspen forest
-  Unimproved road
-  Stream
-  Spring
-  Boreal toad location
-  Hibernaculum
- Other areas consist of rock base/grass interspersion

Scale = 1:5,500
Meters

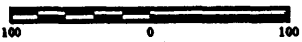

Inset scale 1: 2,200









Toad 773

Date

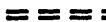
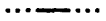
1	5/15/98
2	5/18/98
3	5/19/98
4	5/27/98
5	6/02/98
6	6/09/98
7	6/16/98
8	6/23/98
9	7/01/98
10	7/07/98

Legend

-  Lake or pond
-  Conifer/Aspen forest
-  Unimproved road
-  Stream
-  Spring
-  Boreal toad location
-  Hibernaculum
- Other areas consist of rock base/grass interspersion

Scale = 1:5,500
Meters

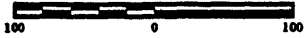





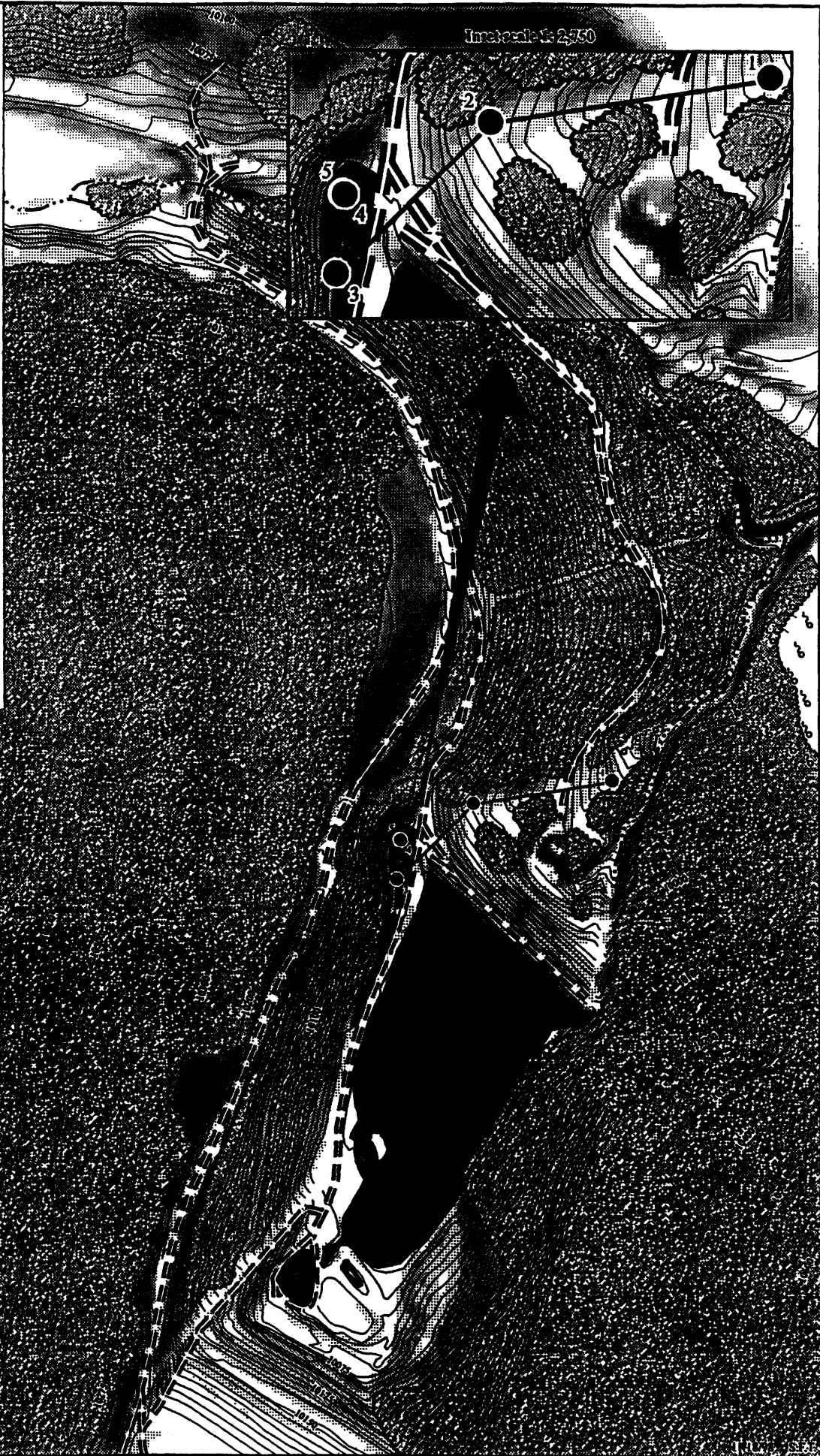

Toad 920

#	Date
1	5/19/98
2	5/27/98
3	6/03/98
4	6/09/98
5	6/16/98

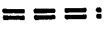

Legend

-  Lake or pond
 -  Conifer/Aspen forest
 -  Unimproved road
 -  Stream
 -  Spring
 -  Boreal toad location
 -  Hibernaculum
- Other areas consist of
rock base/grass interspersions

Scale = 1:5,500
Meters







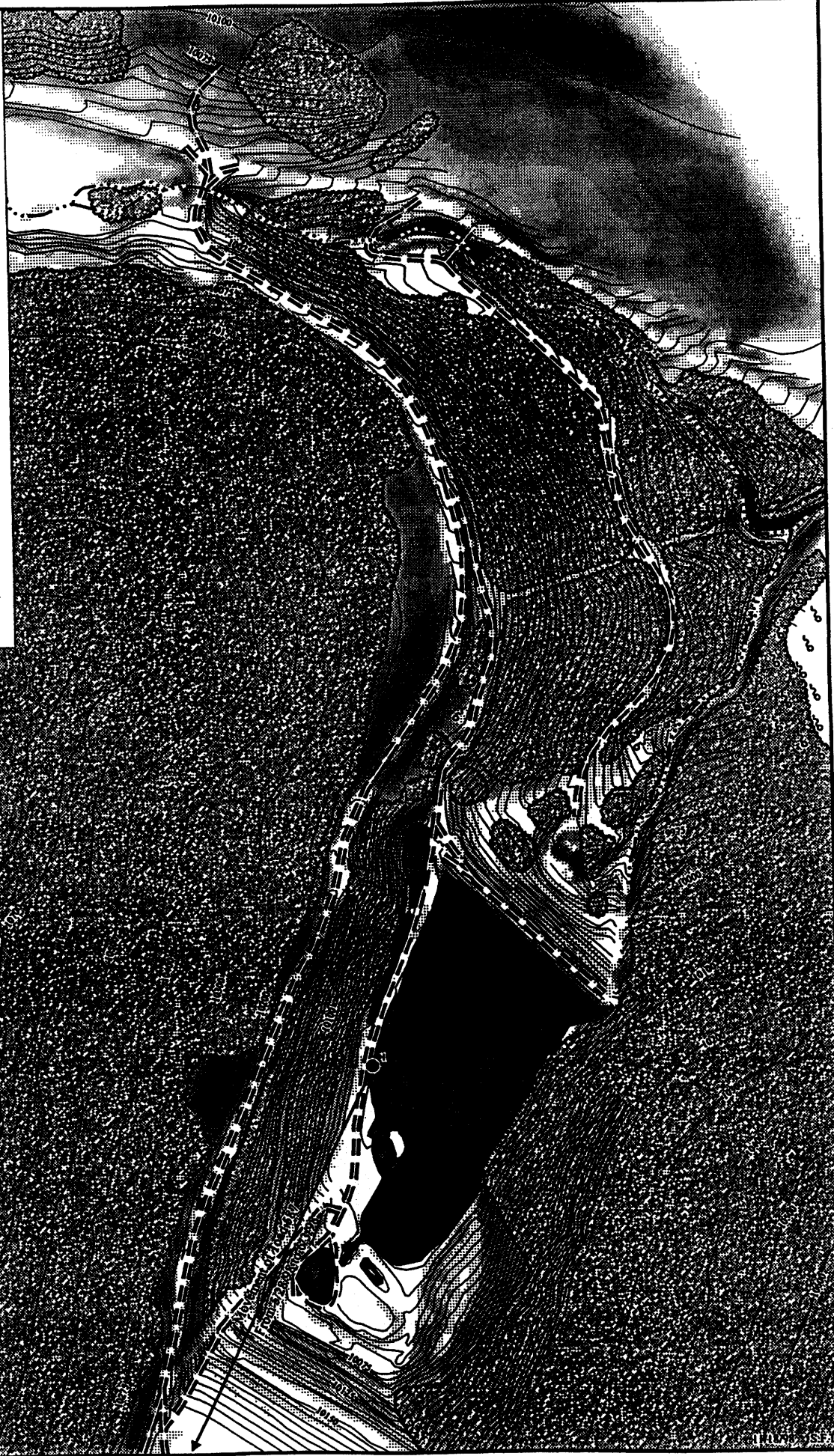

Toad 587

Date

1 5/28/98



Legend

-  Lake or pond
-  Conifer/Aspen forest
-  Unimproved road
-  Stream
-  Spring
-  Boreal toad location
-  Hibernaculum

Other areas consist of
rock base/grass interspersion

Scale = 1:5,500
Meters

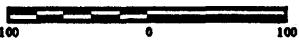





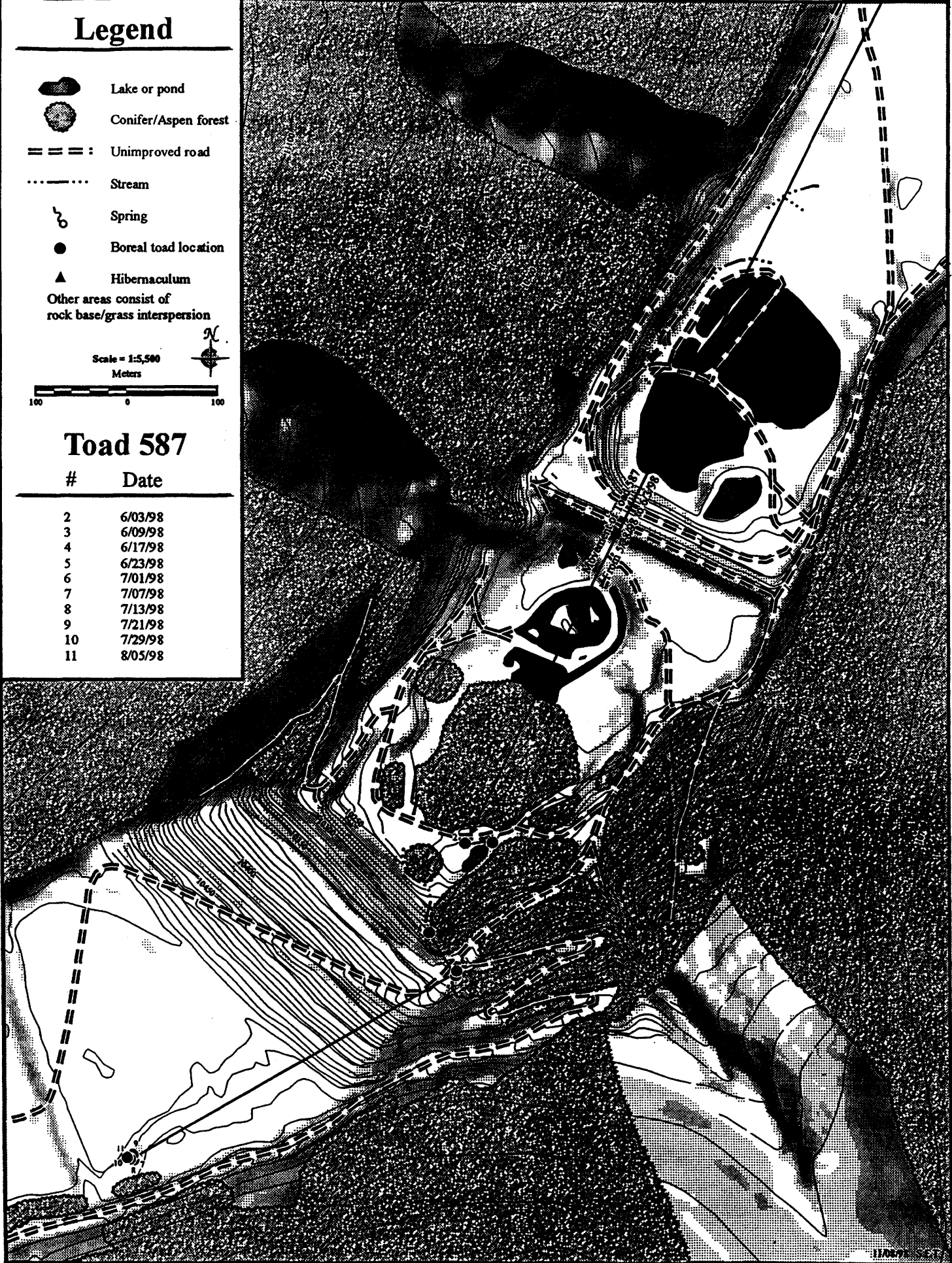

Toad 587

Date

2	6/03/98
3	6/09/98
4	6/17/98
5	6/23/98
6	7/01/98
7	7/07/98
8	7/13/98
9	7/21/98
10	7/29/98
11	8/05/98



Legend

-  Lake or pond
 -  Conifer/Aspen forest
 -  Unimproved road
 -  Stream
 -  Spring
 -  Boreal toad location
 -  Hibernaculum
- Other areas consist of
rock base/grass interspersion

Scale = 1:5,500
Meters







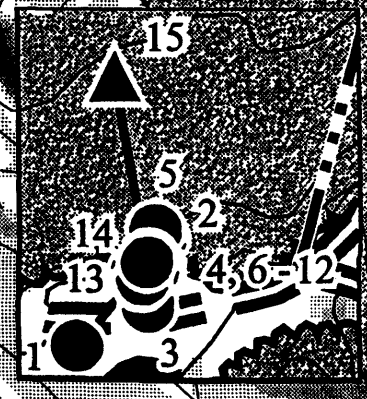
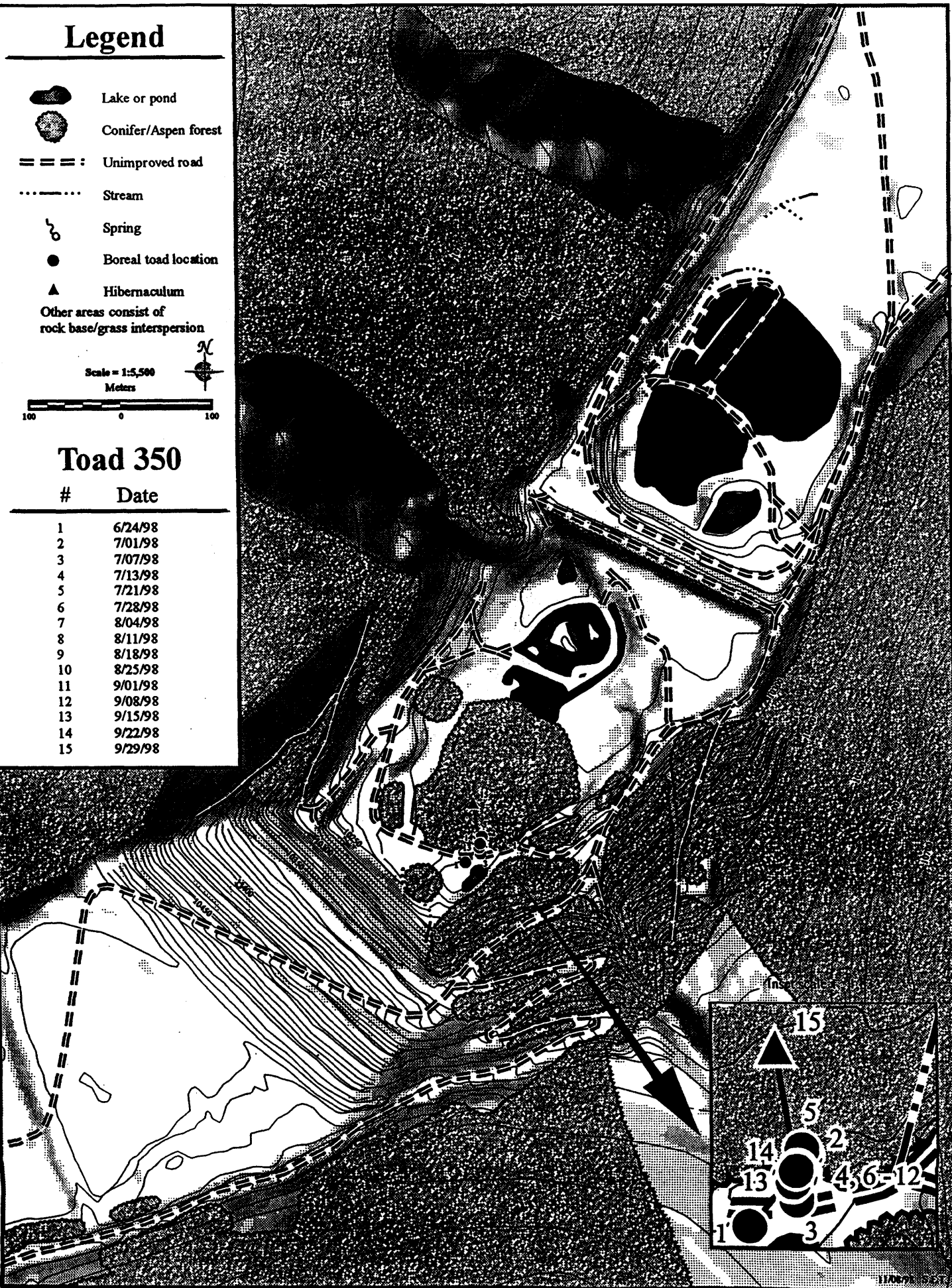

Toad 350

Date

1	6/24/98
2	7/01/98
3	7/07/98
4	7/13/98
5	7/21/98
6	7/28/98
7	8/04/98
8	8/11/98
9	8/18/98
10	8/25/98
11	9/01/98
12	9/08/98
13	9/15/98
14	9/22/98
15	9/29/98



Legend

-  Lake or pond
 -  Conifer/Aspen forest
 -  Unimproved road
 -  Stream
 -  Spring
 -  Boreal toad location
 -  Hibernaculum
- Other areas consist of
rock base/grass interspersion

Scale = 1:5,500
Meters







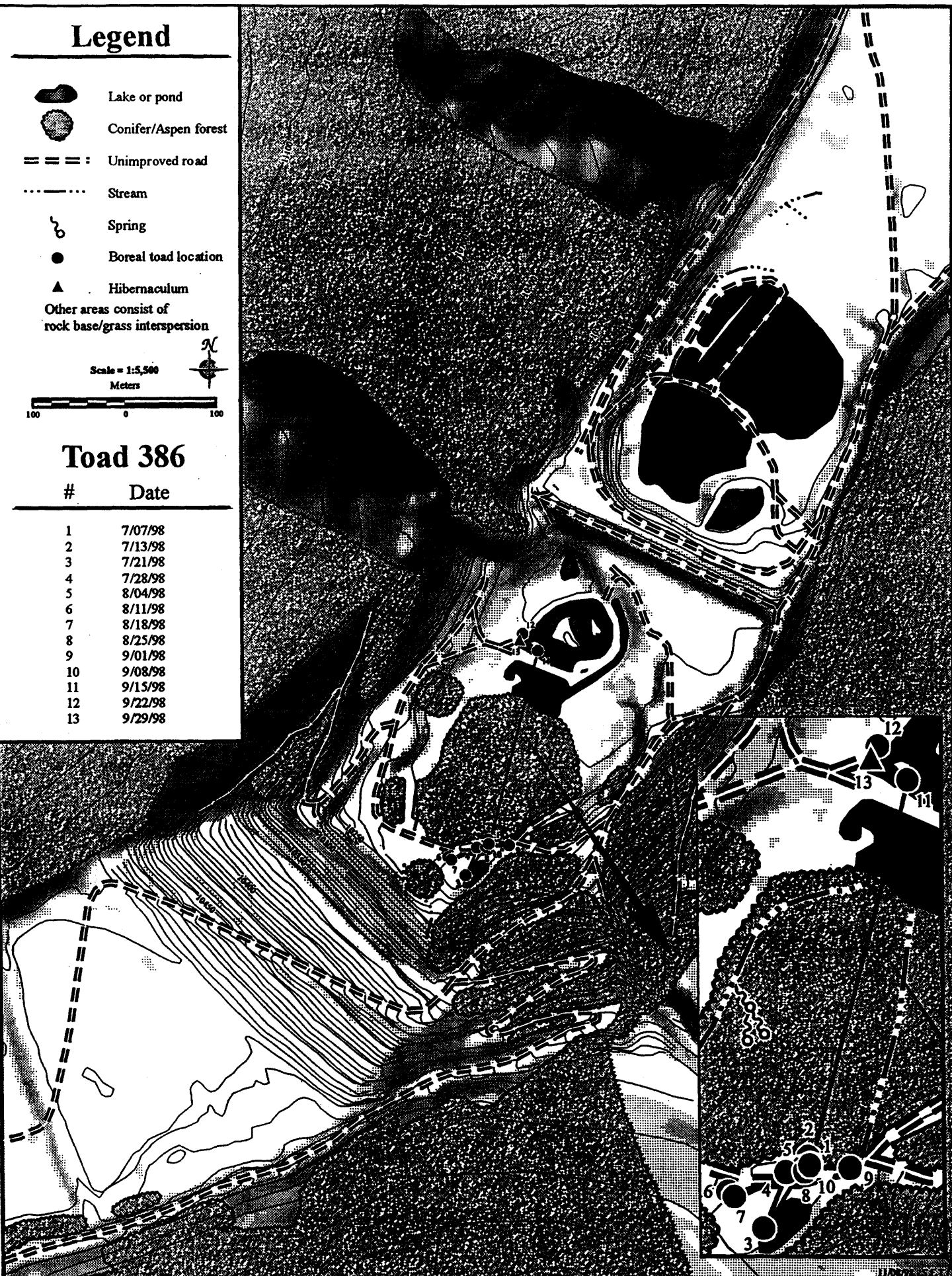

Toad 386

Date

1	7/07/98
2	7/13/98
3	7/21/98
4	7/28/98
5	8/04/98
6	8/11/98
7	8/18/98
8	8/25/98
9	9/01/98
10	9/08/98
11	9/15/98
12	9/22/98
13	9/29/98



Legend

-  Lake or pond
 -  Conifer/Aspen forest
 -  Unimproved road
 -  Stream
 -  Spring
 -  Boreal toad location
 -  Hibernaculum
- Other areas consist of
rock base/grass interspersions

Scale = 1:5,500
Meters







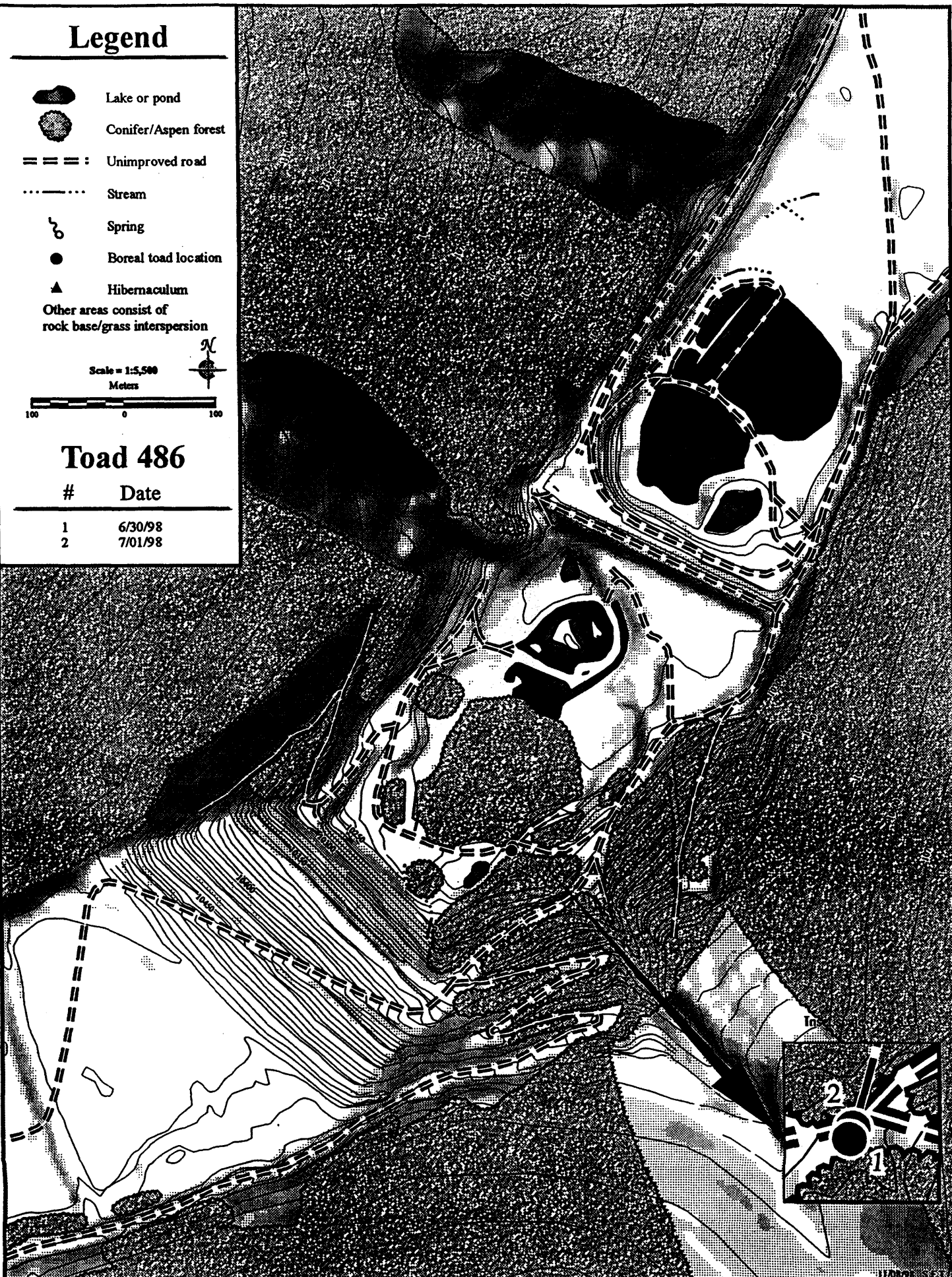

Toad 486

Date

1	6/30/98
2	7/01/98

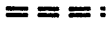

Legend

-  Lake or pond
 -  Conifer/Aspen forest
 -  Unimproved road
 -  Stream
 -  Spring
 -  Boreal toad location
 -  Hibernaculum
- Other areas consist of
rock base/grass interspersions

Scale = 1:5,500
Meters

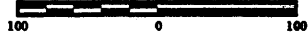

Toad 575



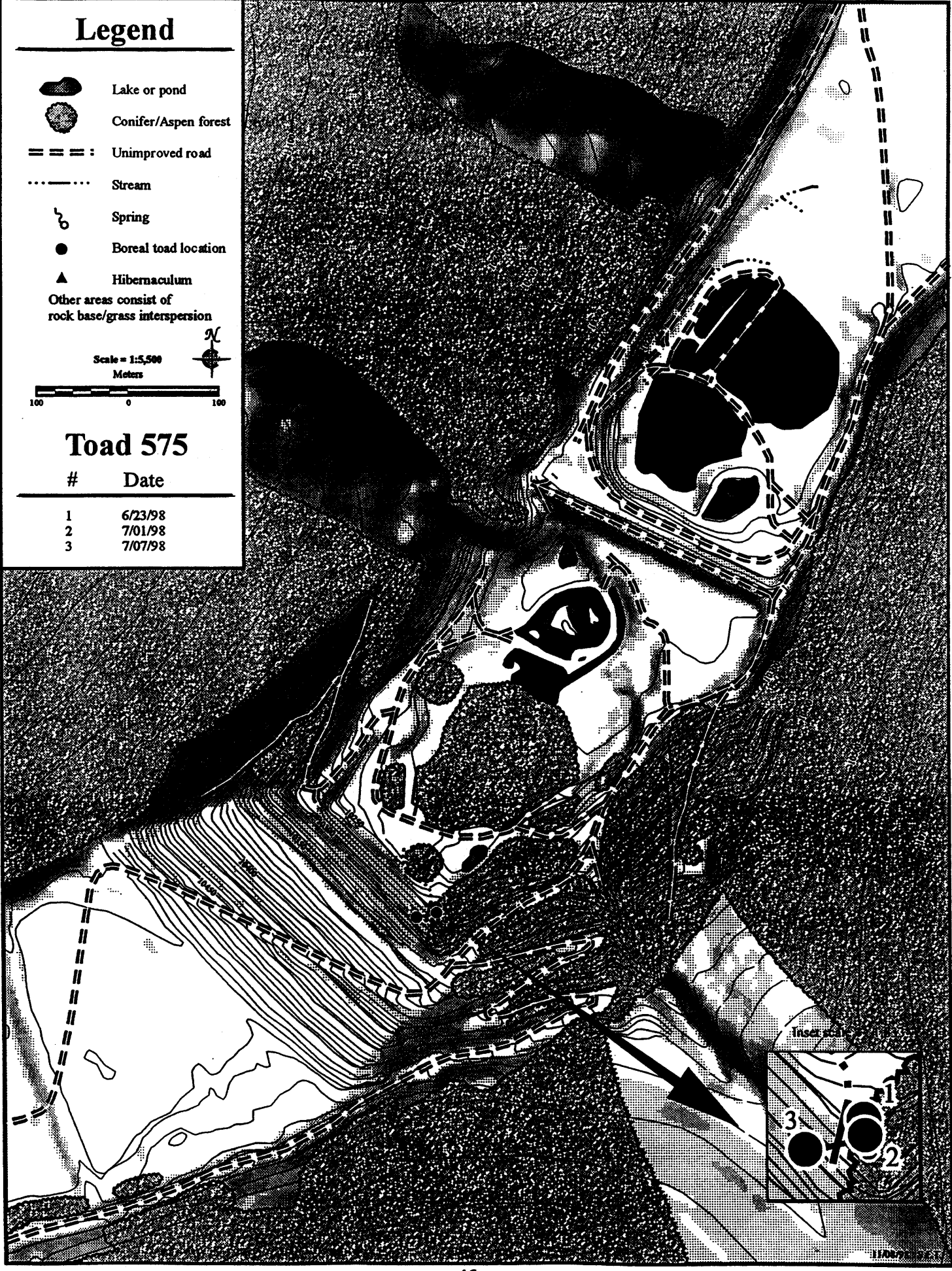

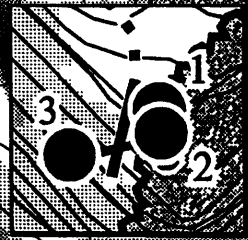

#	Date
1	6/23/98
2	7/01/98
3	7/07/98



Inset map

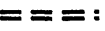

Legend

-  Lake or pond
 -  Conifer/Aspen forest
 -  Unimproved road
 -  Stream
 -  Spring
 -  Boreal toad location
 -  Hibernaculum
- Other areas consist of rock base/grass interspersions

Scale = 1:5,500
Meters







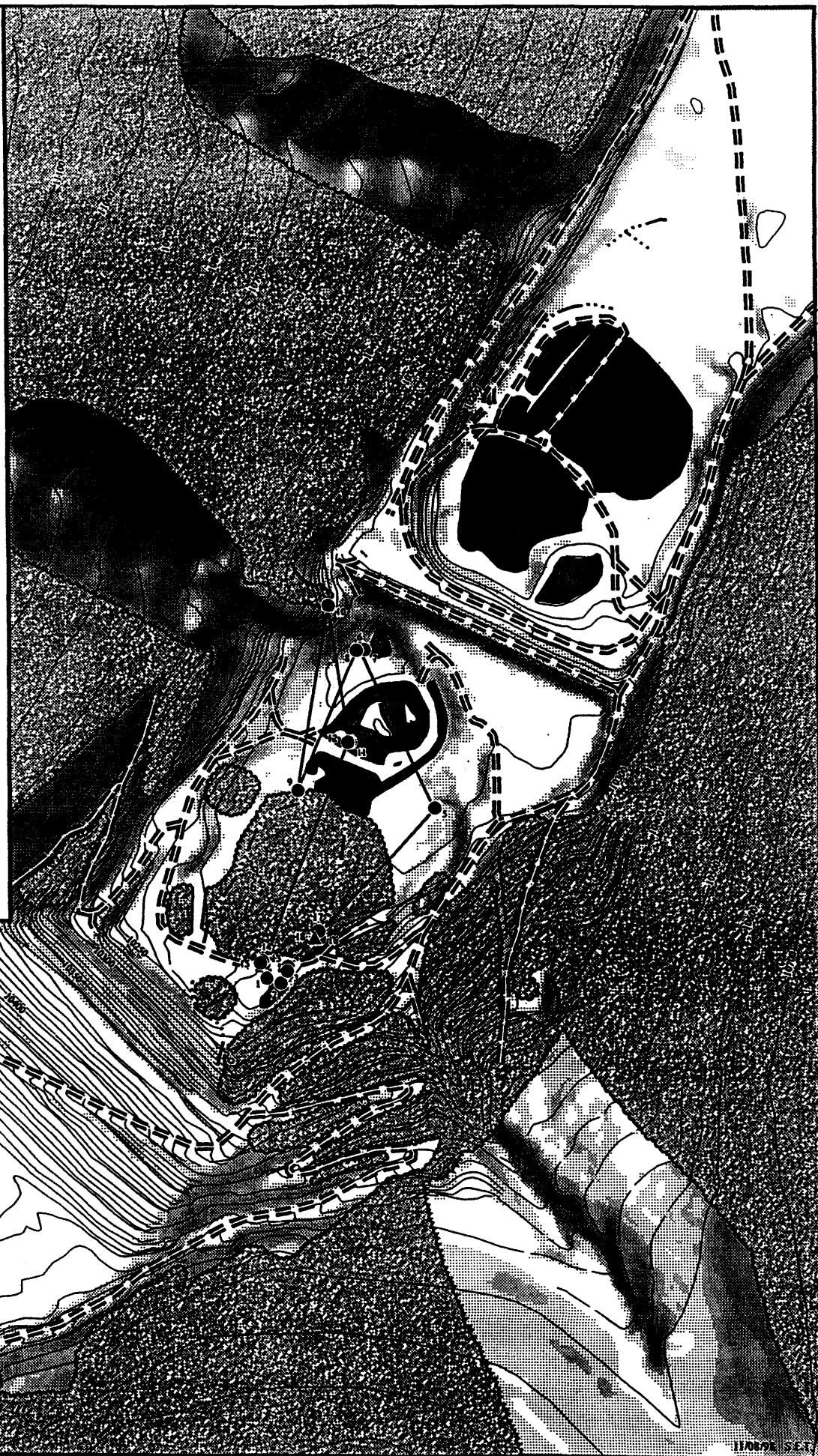

Toad 585

Date

#	Date
1	6/03/98
2	6/09/98
3	6/17/98
4	6/23/98
5	7/01/98
6	7/07/98
7	7/13/98
8	7/22/98
9	7/28/98
10	8/04/98
11	8/11/98
12	8/18/98
13	8/25/98
14	9/01/98
15	9/08/98
16	9/15/98
17	9/22/98
18	9/29/98



Legend

-  Lake or pond
 -  Conifer/Aspen forest
 -  Unimproved road
 -  Stream
 -  Spring
 -  Boreal toad location
 -  Hibernaculum
- Other areas consist of
rock base/grass interspersion

Scale = 1:5,500
Meters

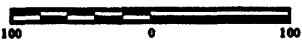





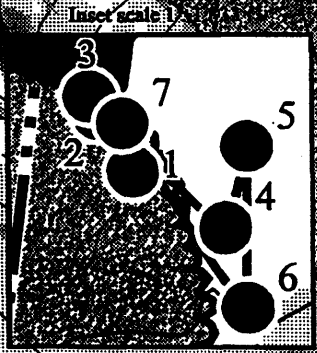
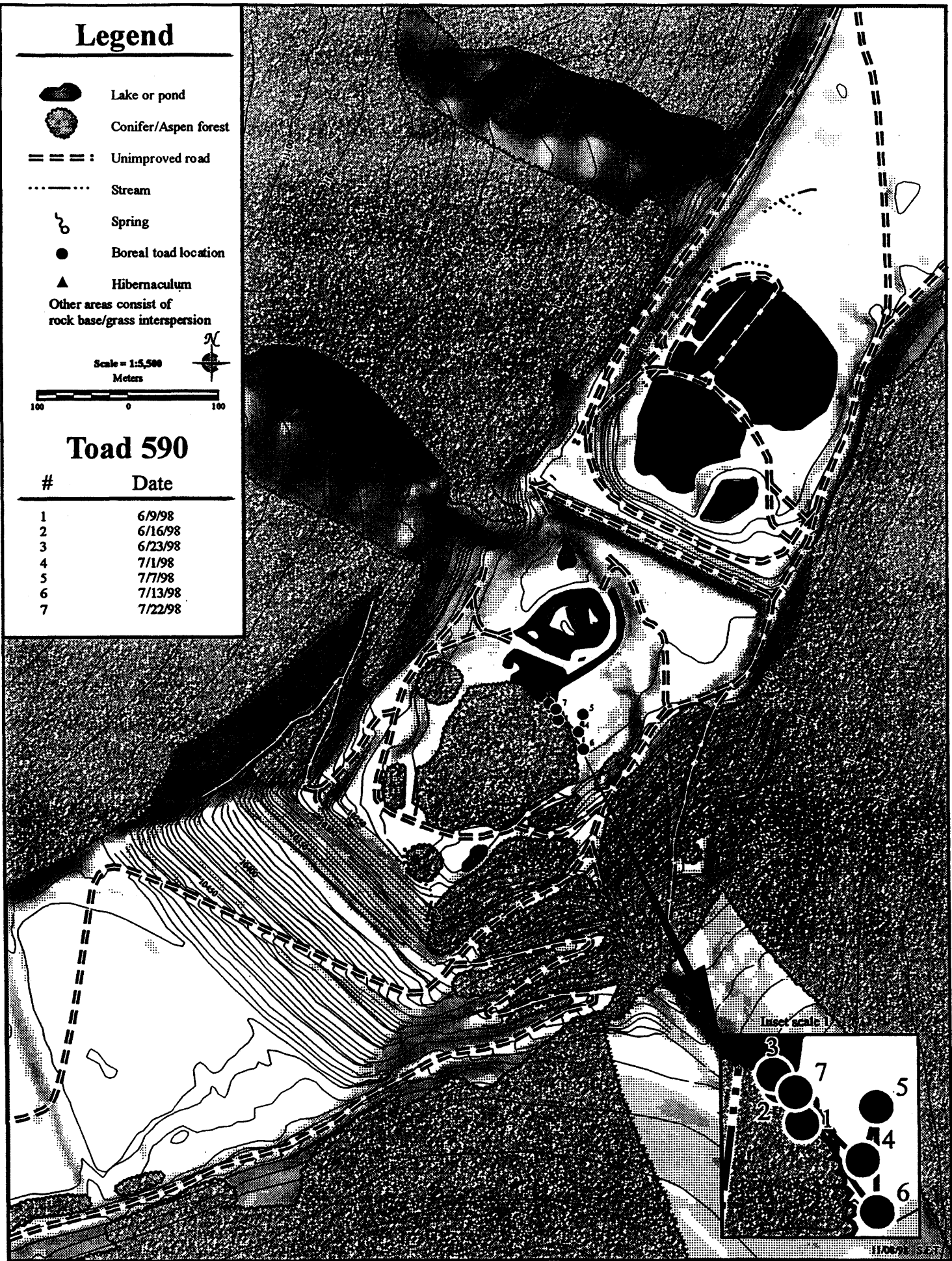

Toad 590

#	Date
1	6/9/98
2	6/16/98
3	6/23/98
4	7/1/98
5	7/7/98
6	7/13/98
7	7/22/98



Legend

-  Lake or pond
 -  Conifer/Aspen forest
 -  Unimproved road
 -  Stream
 -  Spring
 -  Boreal toad location
 -  Hibernaculum
- Other areas consist of rock base/grass interspersion

Scale = 1:5,500
Meters

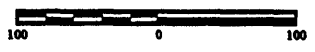

Toad 591



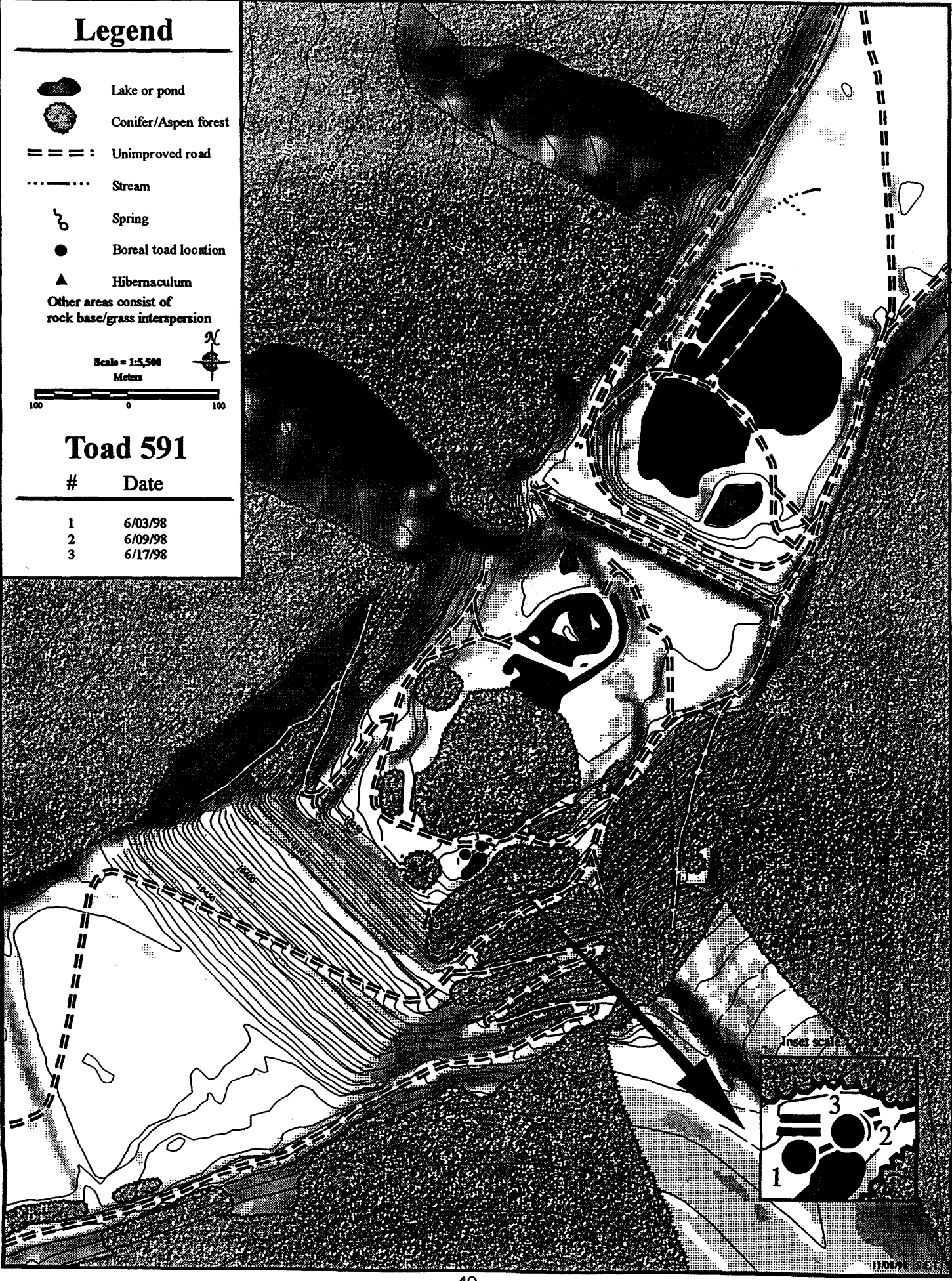

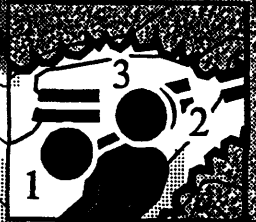

#	Date
1	6/03/98
2	6/09/98
3	6/17/98



Inset scale



Legend

-  Lake or pond
 -  Conifer/Aspen forest
 -  Unimproved road
 -  Stream
 -  Spring
 -  Boreal toad location
 -  Hibernaculum
- Other areas consist of
rock base/grass interspersion

Scale = 1:5,500
Meters







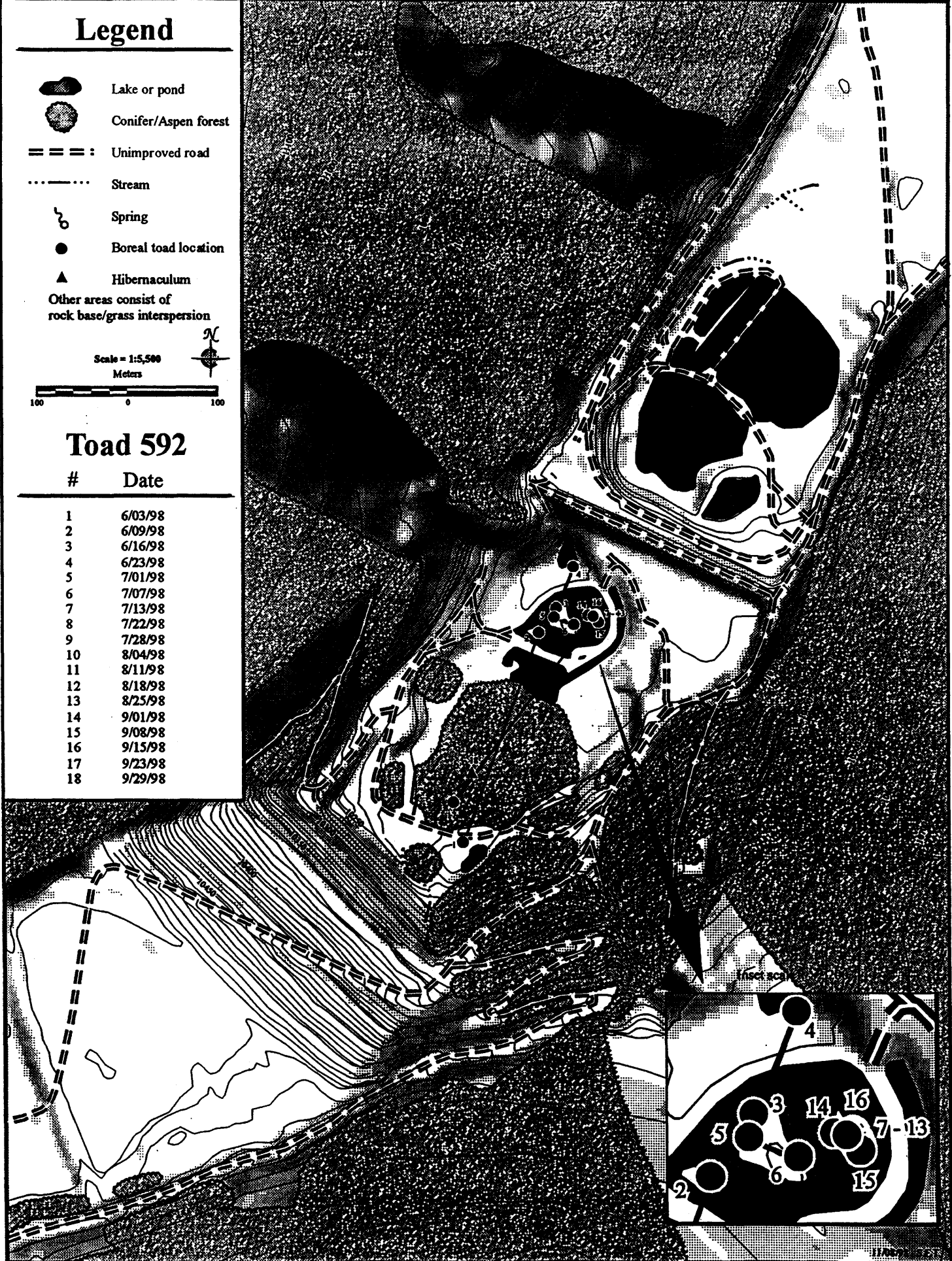

Toad 592

Date

1	6/03/98
2	6/09/98
3	6/16/98
4	6/23/98
5	7/01/98
6	7/07/98
7	7/13/98
8	7/22/98
9	7/28/98
10	8/04/98
11	8/11/98
12	8/18/98
13	8/25/98
14	9/01/98
15	9/08/98
16	9/15/98
17	9/23/98
18	9/29/98



Legend

-  Lake or pond
-  Conifer/Aspen forest
-  Unimproved road
-  Stream
-  Spring
-  Boreal toad location
-  Hibernaculum

Other areas consist of
rock base/grass interspersion

Scale = 1:5,500
Meters







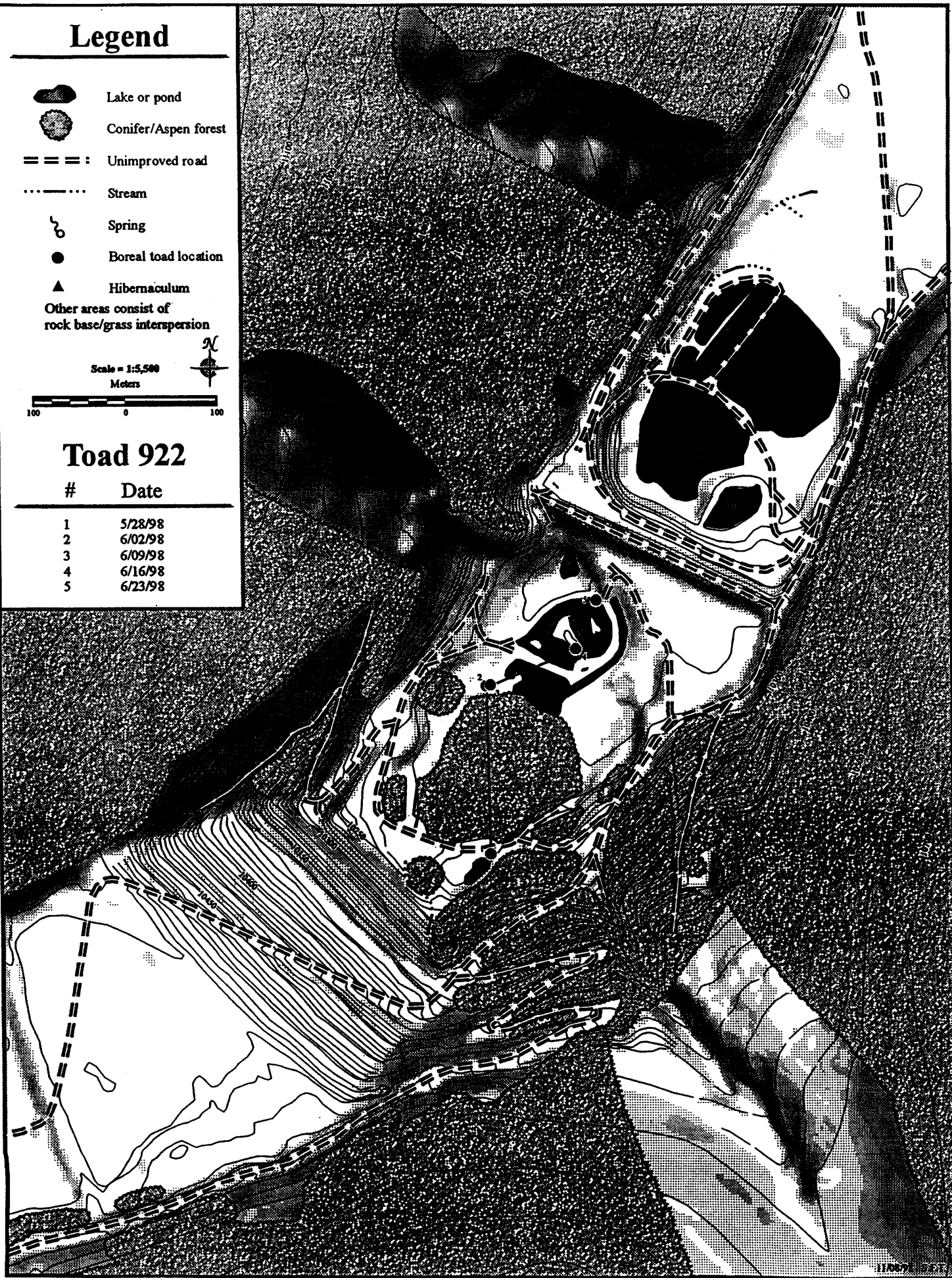

Toad 922

#	Date
1	5/28/98
2	6/02/98
3	6/09/98
4	6/16/98
5	6/23/98

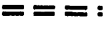

Legend

-  Lake or pond
 -  Conifer/Aspen forest
 -  Unimproved road
 -  Stream
 -  Spring
 -  Boreal toad location
 -  Hibernaculum
- Other areas consist of
rock base/grass interspersion

Scale = 1:5,500
Meters









Toad 576

#	Date
1	5/15/98
2	5/18/98
3	5/19/98
4	5/27/98
5	6/02/98
6	6/09/98
7	6/16/98
8	6/23/98
9	7/01/98
10	7/07/98



Legend

-  Lake or pond
 -  Conifer/Aspen forest
 -  Unimproved road
 -  Stream
 -  Spring
 -  Boreal toad location
 -  Hibernaculum
- Other areas consist of
rock base/grass interspersion

Scale = 1:5,500
Meters

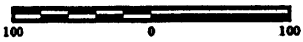





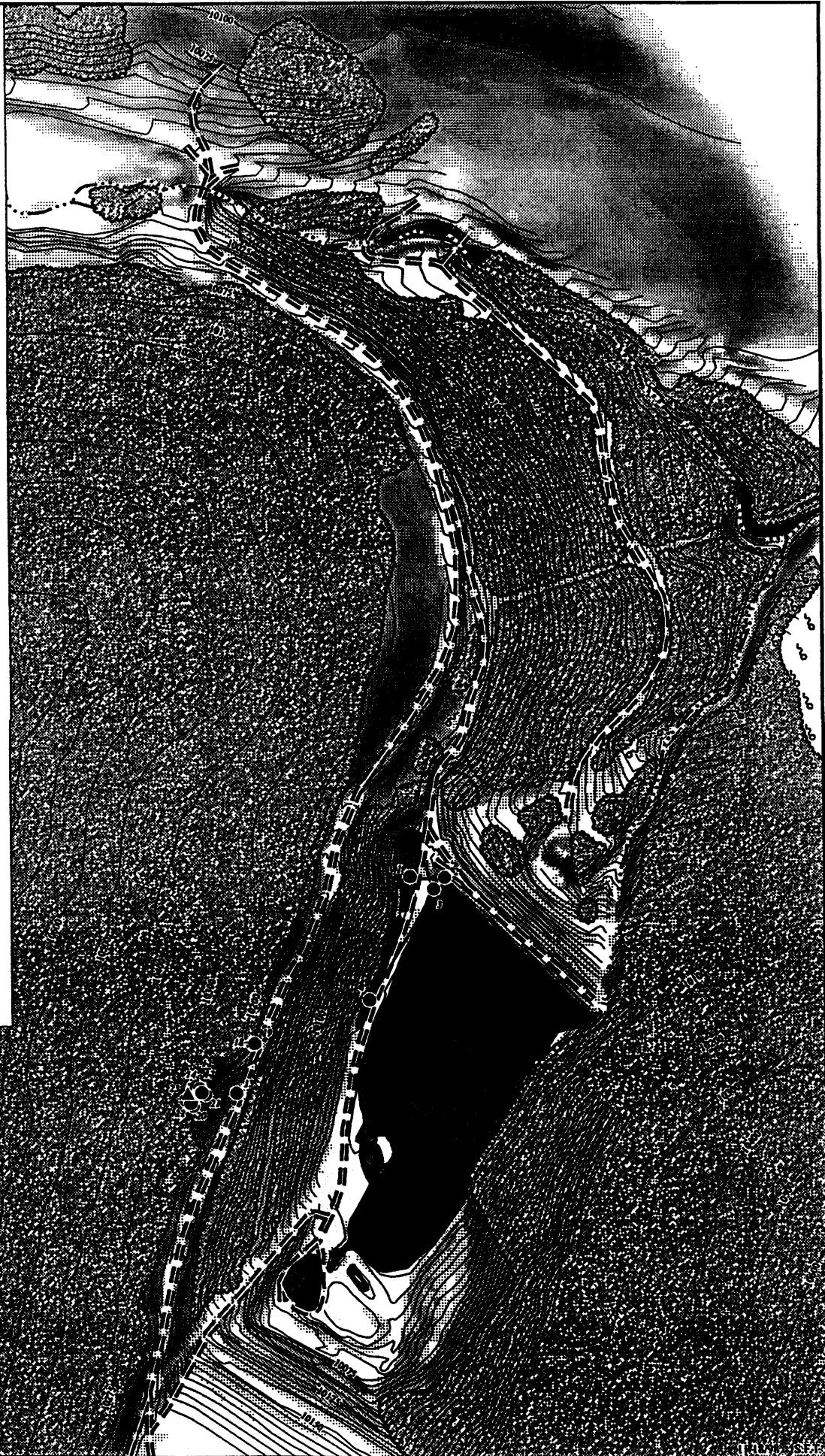

Toad 574

Date

1	5/15/98
2	5/18/98
3	5/19/98
4	5/20/98
5	5/27/98
6	6/04/98
7	6/09/98
8	6/16/98
9	6/23/98
10	7/01/98
11	7/08/98
12	7/13/98
13	7/22/98
14	7/28/98
15	8/05/98
16	8/11/98
17	8/18/98
18	8/25/98
19	9/01/98
20	9/08/98
21	9/15/98
22	9/22/98
23	9/29/98



Legend

-  Lake or pond
 -  Conifer/Aspen forest
 -  Unimproved road
 -  Stream
 -  Spring
 -  Boreal toad location
 -  Hibernaculum
- Other areas consist of
rock base/grass interspersion

Scale = 1:5,500
Meters

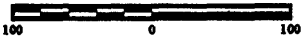





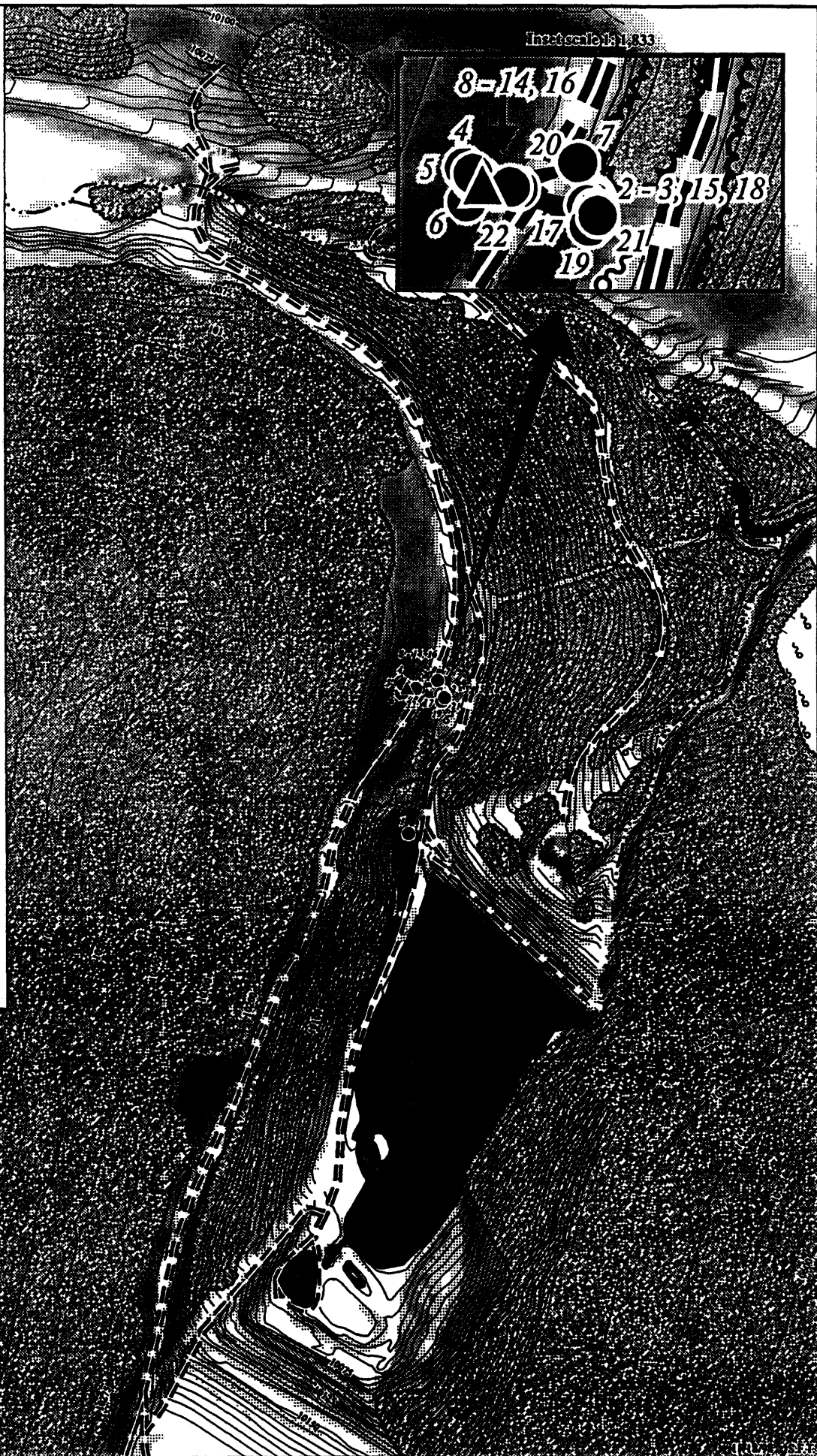

Toad 572

#	Date
1	5/15/98
2	5/18/98
3	5/19/98
4	5/27/98
5	6/02/98
6	6/09/98
7	6/16/98
8	6/23/98
9	7/01/98
10	7/07/98
11	7/13/98
12	7/21/98
13	7/28/98
14	8/04/98
15	8/11/98
16	8/18/98
17	8/25/98
18	9/01/98
19	9/08/98
20	9/15/98
21	9/22/98
22	9/29/98



Legend

-  Lake or pond
 -  Conifer/Aspen forest
 -  Unimproved road
 -  Stream
 -  Spring
 -  Boreal toad location
 -  Hibernaculum
- Other areas consist of
rock base/grass interspersion

Scale = 1:5,500
Meters







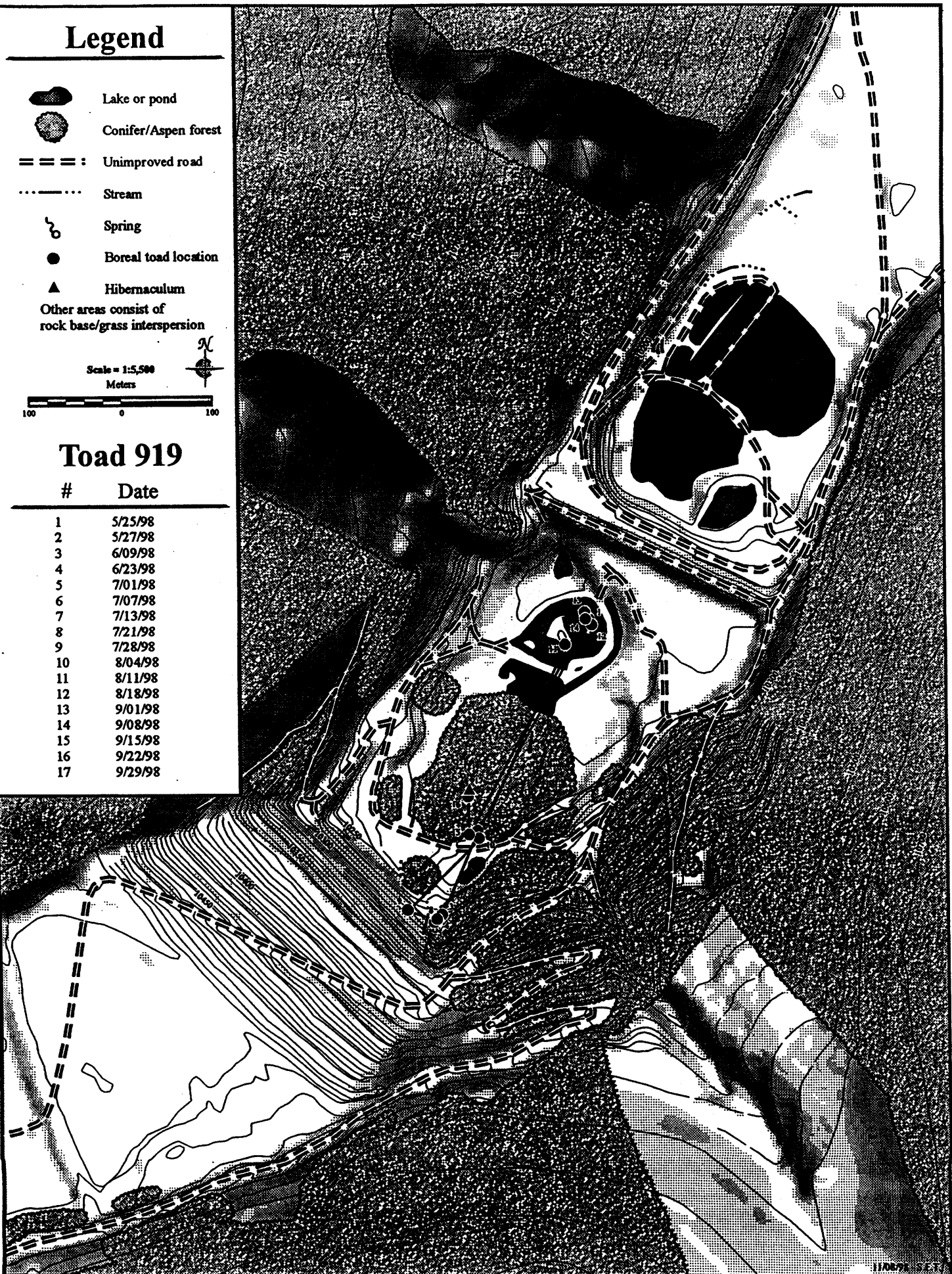

Toad 919

Date

#	Date
1	5/25/98
2	5/27/98
3	6/09/98
4	6/23/98
5	7/01/98
6	7/07/98
7	7/13/98
8	7/21/98
9	7/28/98
10	8/04/98
11	8/11/98
12	8/18/98
13	9/01/98
14	9/08/98
15	9/15/98
16	9/22/98
17	9/29/98



Legend

-  Lake or pond
 -  Conifer/Aspen forest
 -  Unimproved road
 -  Stream
 -  Spring
 -  Boreal toad location
 -  Hibernaculum
- Other areas consist of
rock base/grass interspersion

Scale = 1:5,500
Meters

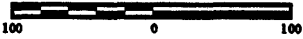





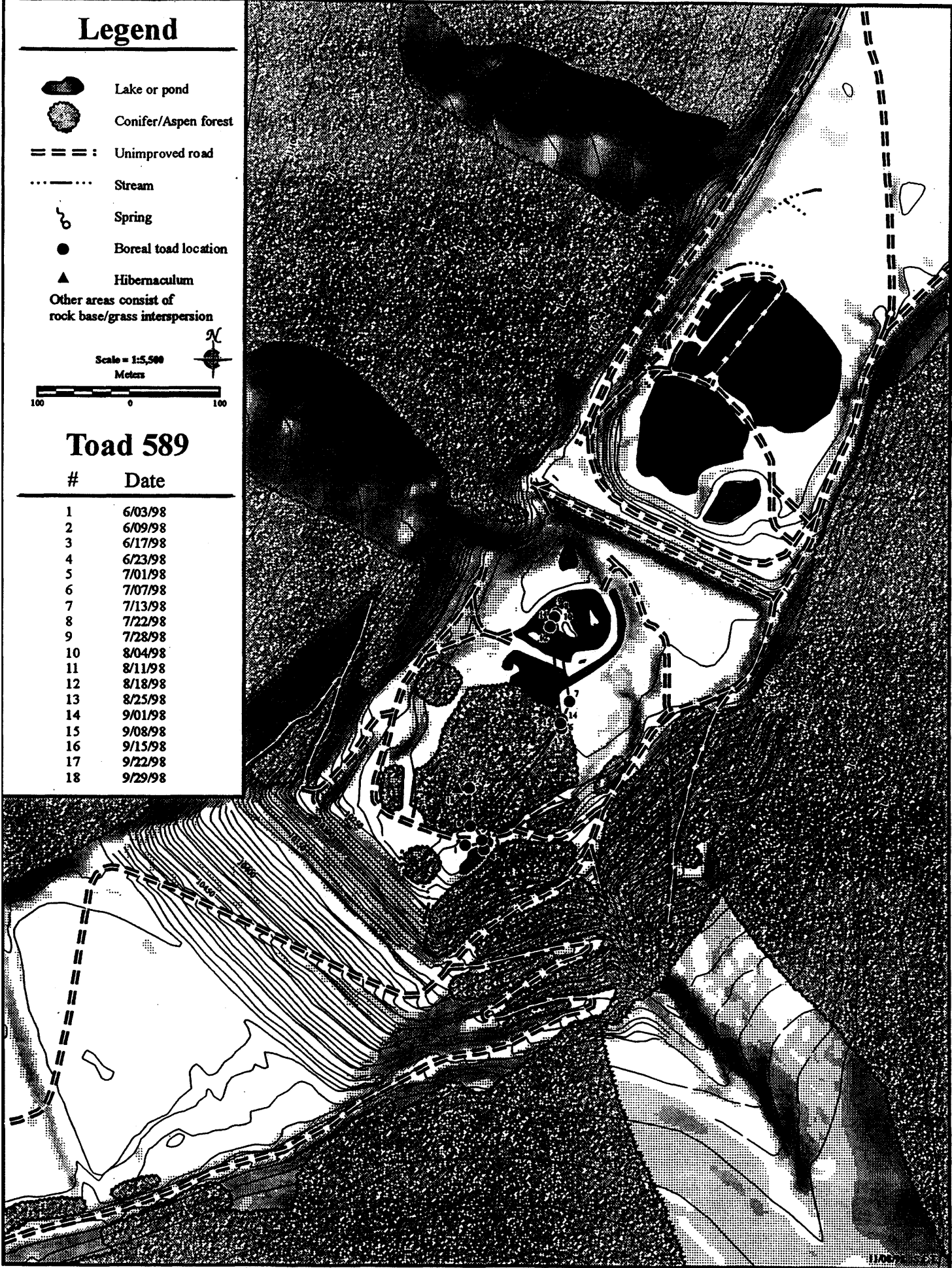

Toad 589

Date

1	6/03/98
2	6/09/98
3	6/17/98
4	6/23/98
5	7/01/98
6	7/07/98
7	7/13/98
8	7/22/98
9	7/28/98
10	8/04/98
11	8/11/98
12	8/18/98
13	8/25/98
14	9/01/98
15	9/08/98
16	9/15/98
17	9/22/98
18	9/29/98

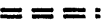

Legend

-  Lake or pond
 -  Conifer/Aspen forest
 -  Unimproved road
 -  Stream
 -  Spring
 -  Boreal toad location
 -  Hibernaculum
- Other areas consist of
rock base/grass interspersion

Scale = 1:5,500
Meters



100 0 100





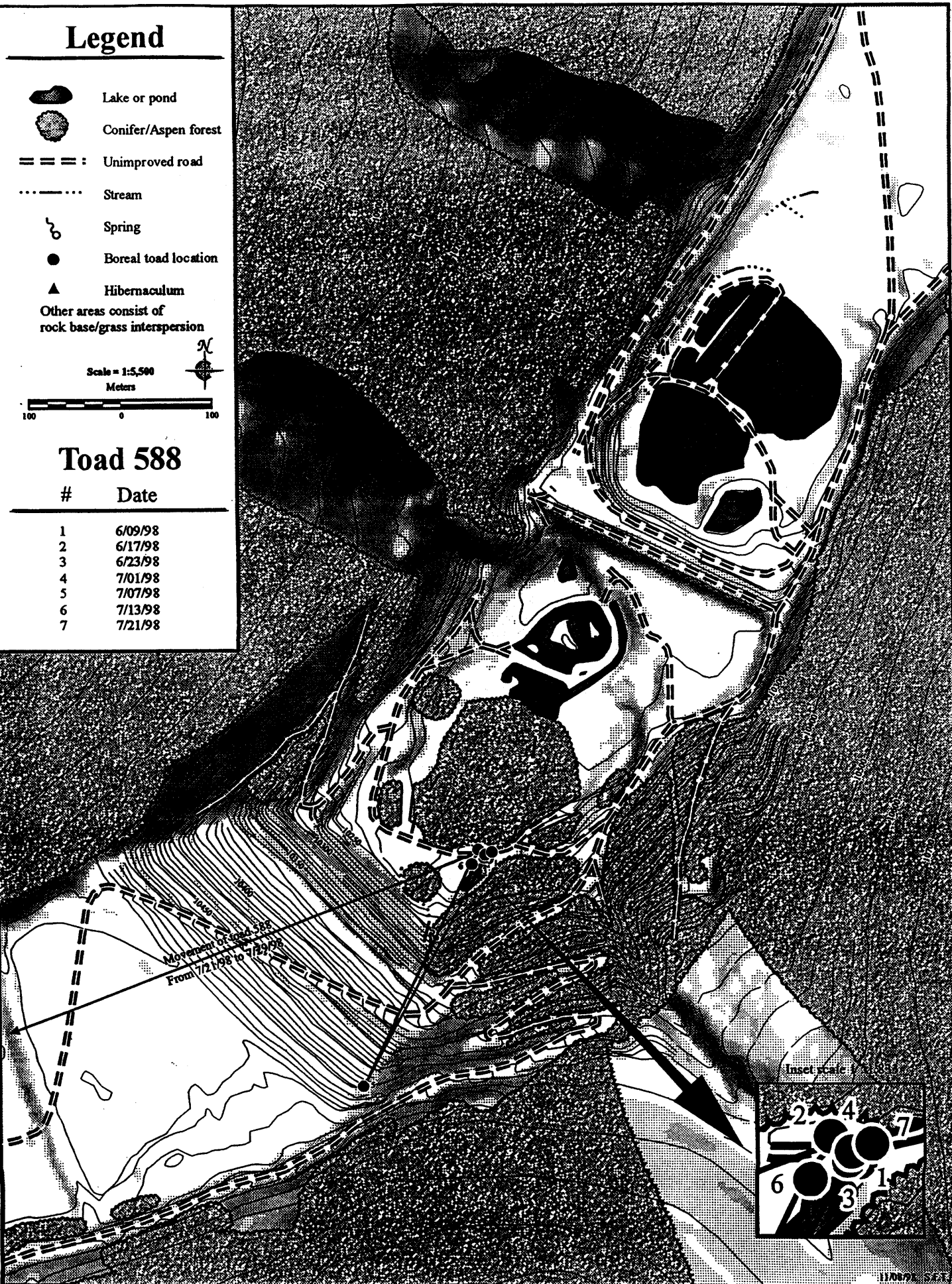

Toad 588

Date

1	6/09/98
2	6/17/98
3	6/23/98
4	7/01/98
5	7/07/98
6	7/13/98
7	7/21/98



Legend

-  Lake or pond
-  Conifer/Aspen forest
-  Unimproved road
-  Stream
-  Spring
-  Boreal toad location
-  Hibernaculum

Other areas consist of
rock base/grass interspersion

Scale = 1:5,500
Meters

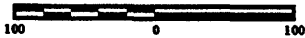





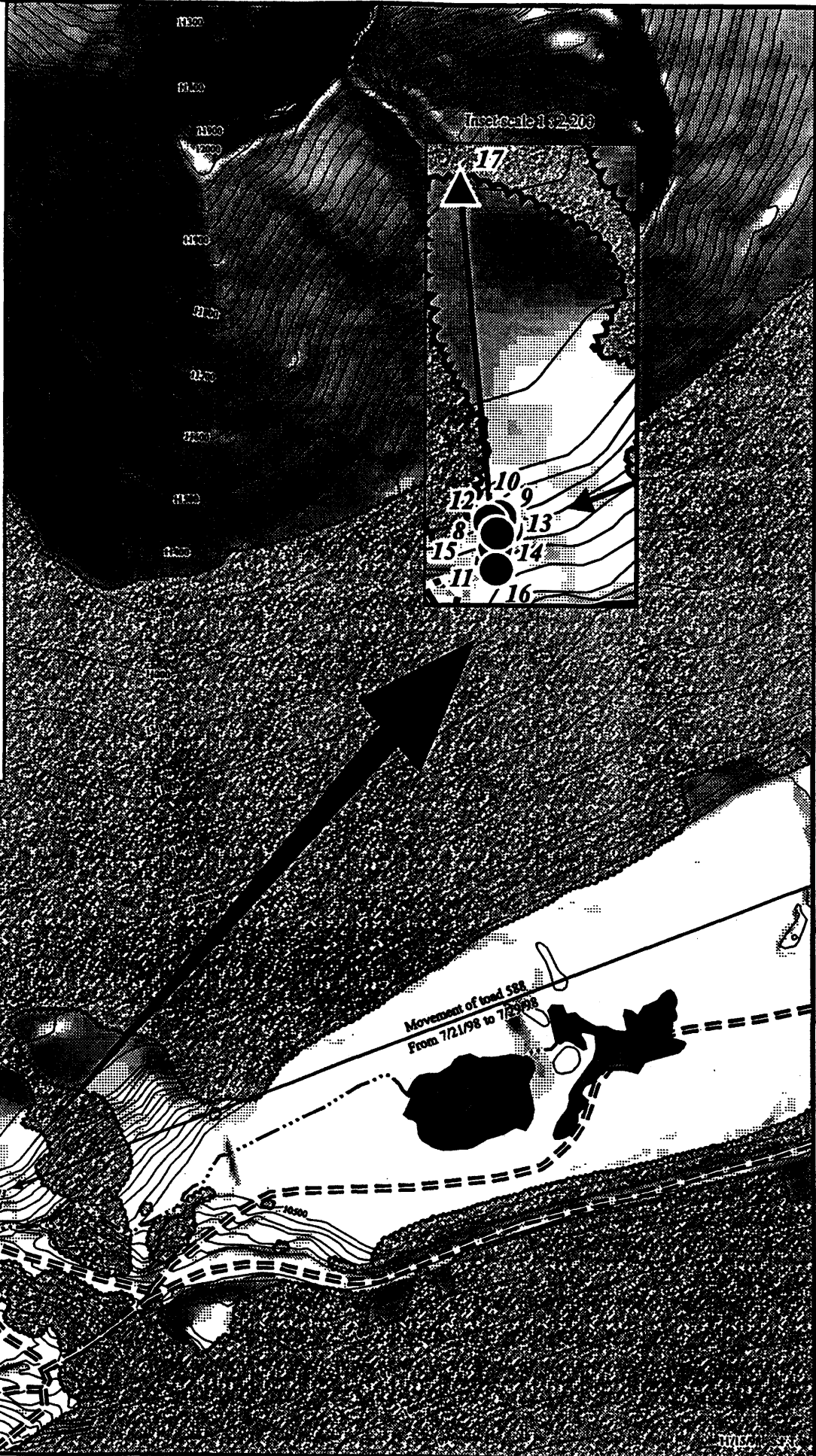

Toad 588

#	Date
8	7/29/98
9	8/05/98
10	8/12/98
11	8/18/98
12	8/25/98
13	9/01/98
14	9/06/98
15	9/15/98
16	9/22/98
17	9/30/98



Legend

-  Lake or pond
 -  Conifer/Aspen forest
 -  Unimproved road
 -  Stream
 -  Spring
 -  Boreal toad location
 -  Hibernaculum
- Other areas consist of
rock base/grass interspersion

Scale = 1:5,500
Meters







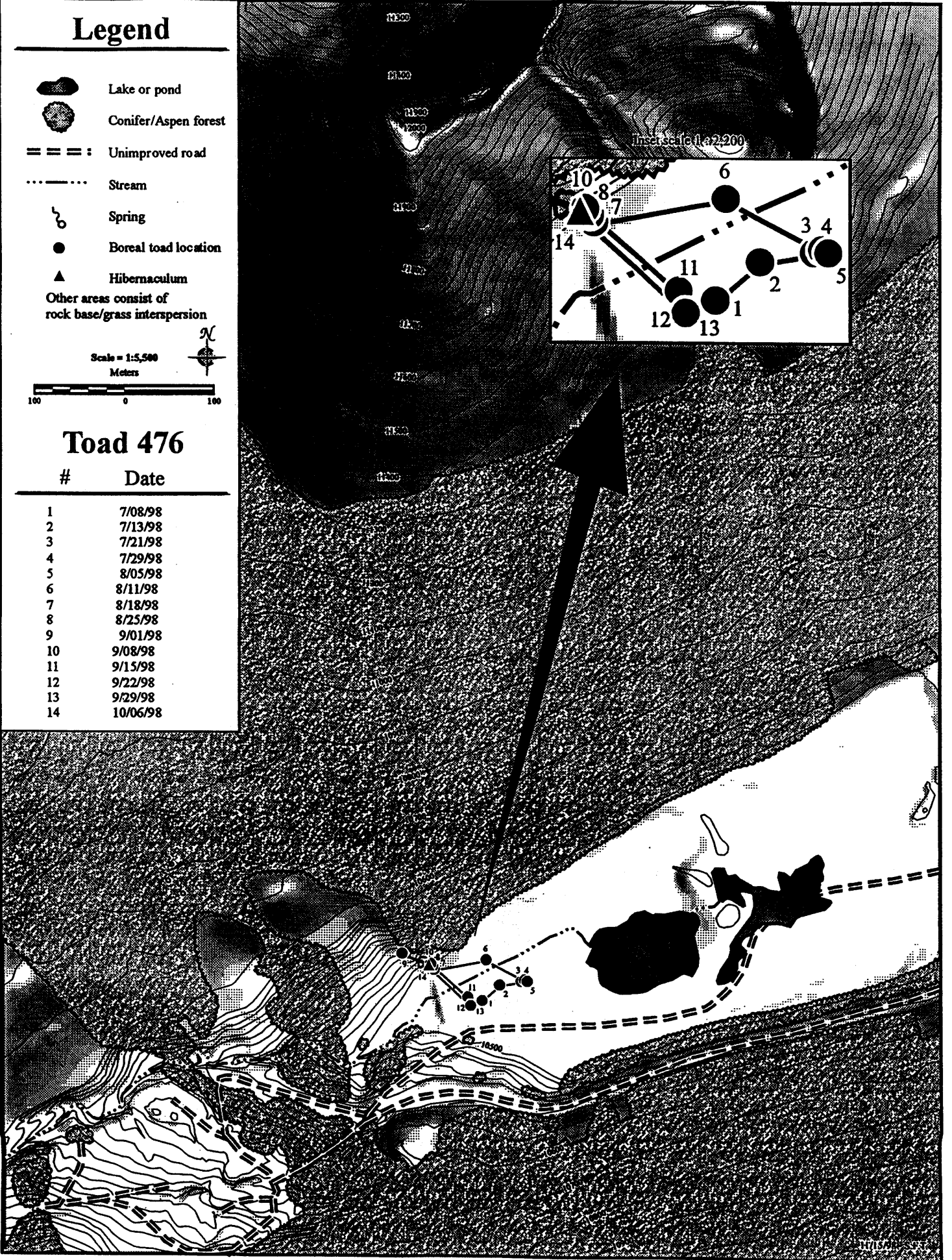
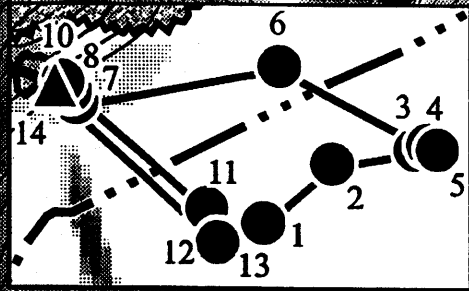

Toad 476

Date

#	Date
1	7/08/98
2	7/13/98
3	7/21/98
4	7/29/98
5	8/05/98
6	8/11/98
7	8/18/98
8	8/25/98
9	9/01/98
10	9/08/98
11	9/15/98
12	9/22/98
13	9/29/98
14	10/06/98



Legend

-  Lake or pond
 -  Conifer/Aspen forest
 -  Unimproved road
 -  Stream
 -  Spring
 -  Boreal toad location
 -  Hibernaculum
- Other areas consist of
rock base/grass interspersions

Scale = 1:5,500
Meters







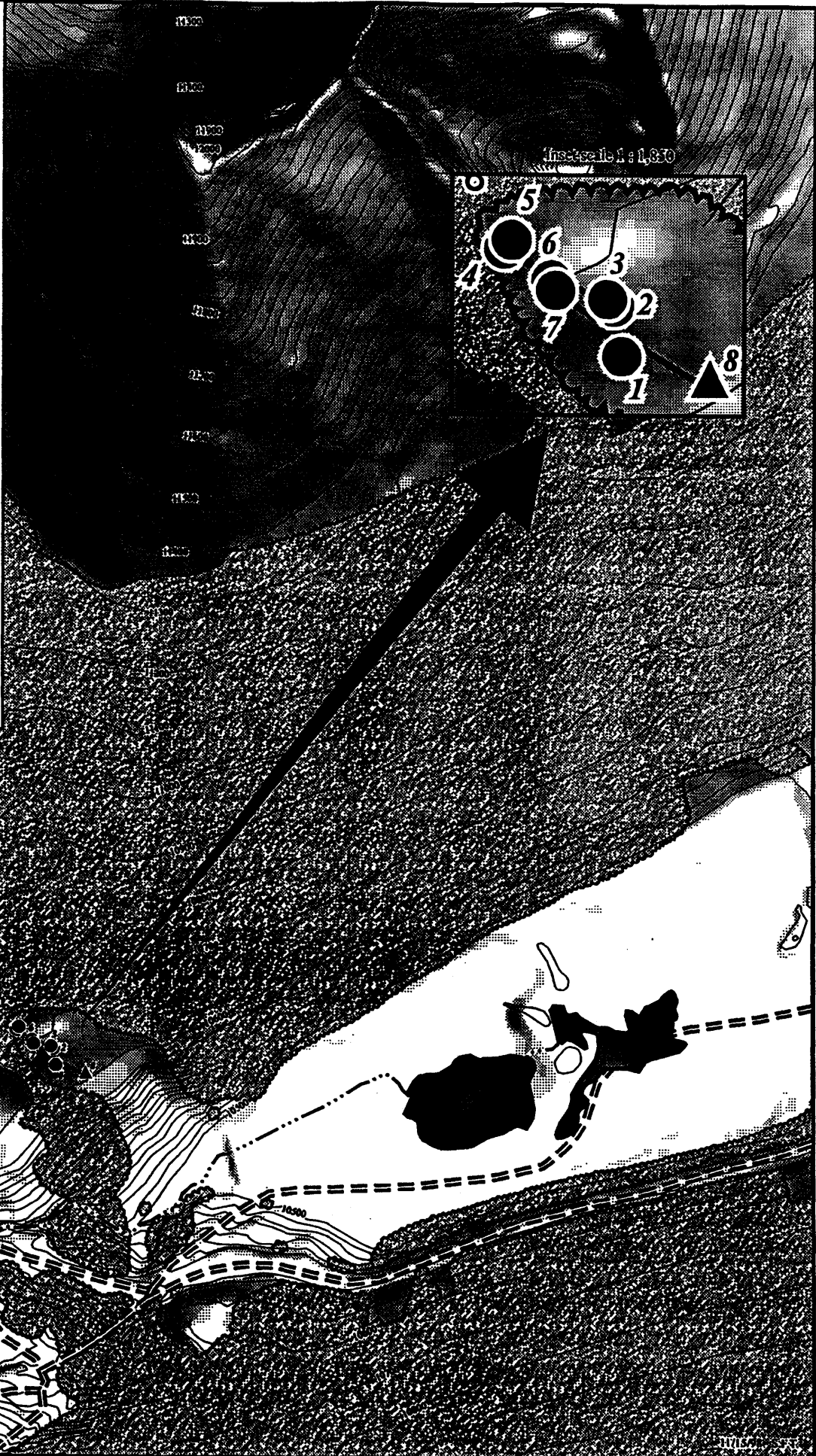

Toad 487

#	Date
1	8/12/98
2	8/19/98
3	8/25/98
4	9/02/98
5	9/08/98
6	9/15/98
7	9/22/98
8	9/29/98



Legend

-  Lake or pond
 -  Conifer/Aspen forest
 -  Unimproved road
 -  Stream
 -  Spring
 -  Boreal toad location
 -  Hibernaculum
- Other areas consist of
rock base/grass interspersion

Scale = 1:5,500
Meters

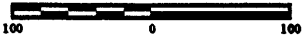





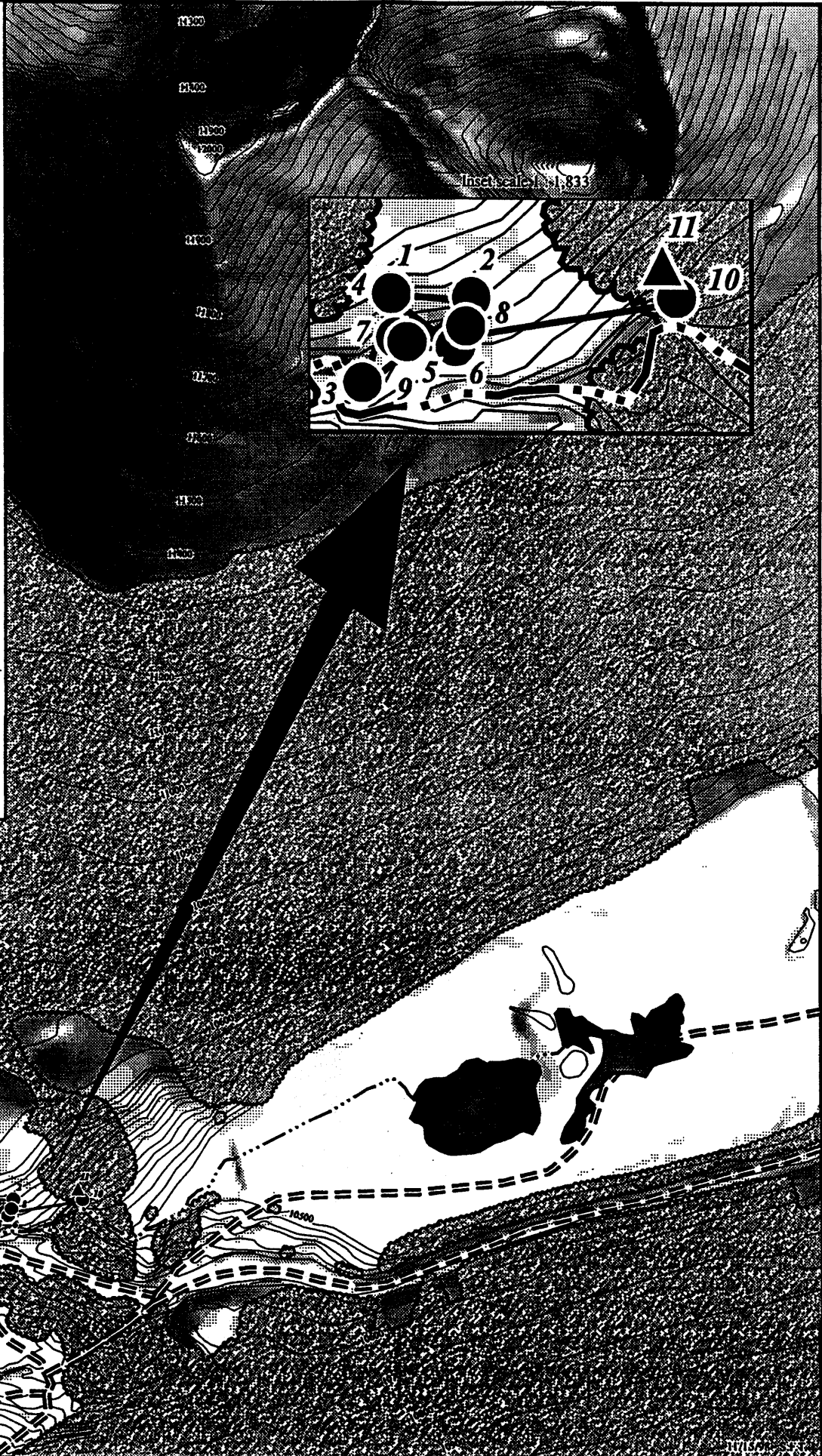

Toad 490

#	Date
1	7/29/98
2	8/05/98
3	8/12/98
4	8/18/98
5	8/25/98
6	9/01/98
7	9/08/98
8	9/15/98
9	9/22/98
10	9/29/98
11	10/6/98



Legend

-  Lake or pond
 -  Conifer/Aspen forest
 -  Unimproved road
 -  Stream
 -  Spring
 -  Boreal toad location
 -  Hibernaculum
- Other areas consist of
rock base/grass interspersion

Scale = 1:5,500
Meters

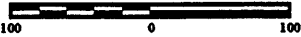

Toad 578

#	Date
1	7/06/98
2	7/13/98
3	7/21/98
4	7/29/98
5	8/05/98
6	8/12/98
7	8/18/98
8	8/25/98
9	9/02/98
10	9/06/98
11	9/15/98
12	9/22/98

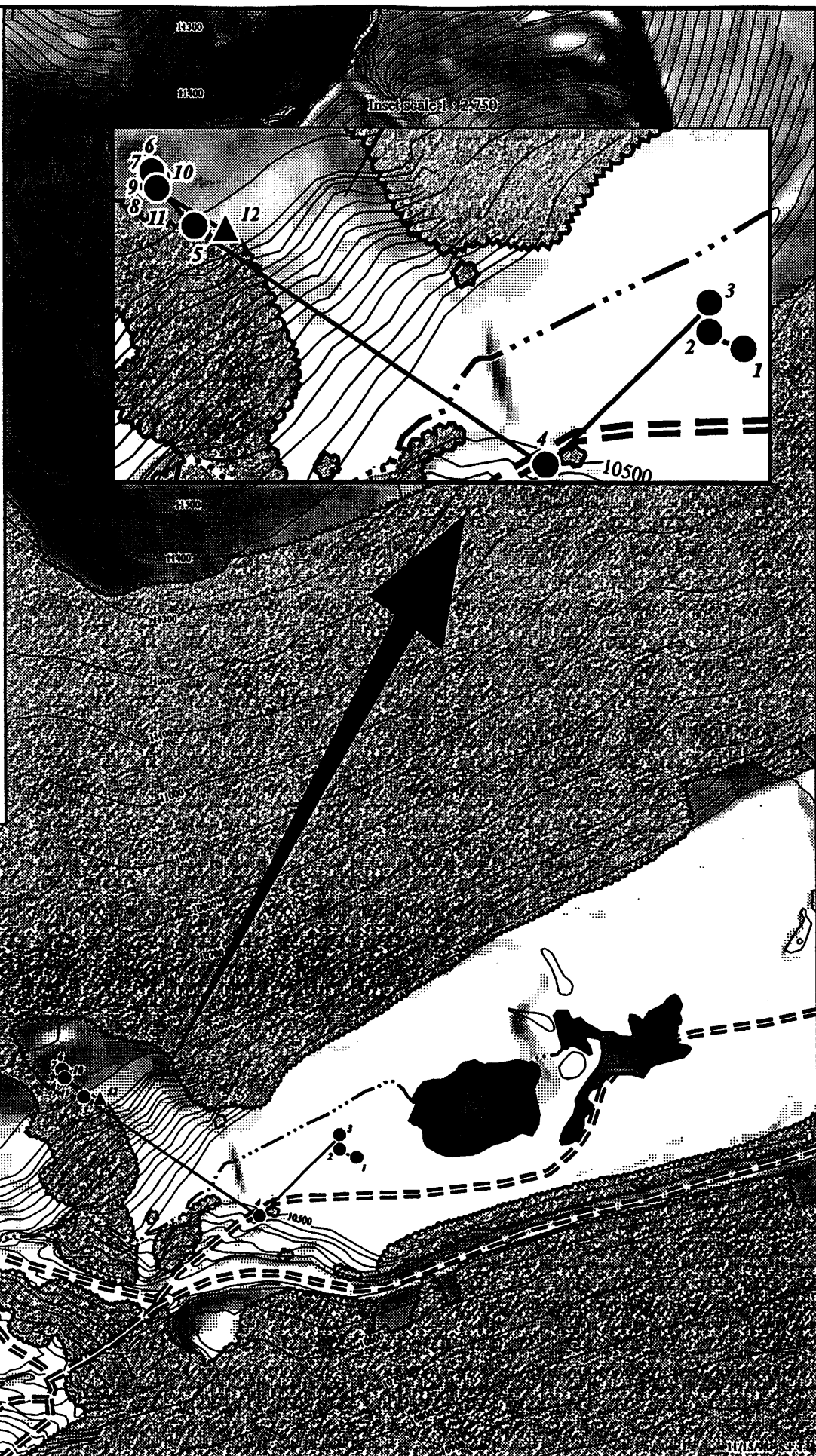

APPENDIX 2.

Home range estimates for boreal toads
in the Henderson/Urad study area, 1998.

4400450
4400440
4400430
4400420
4400410
4400400
4400390
4400380
4400370
4400360

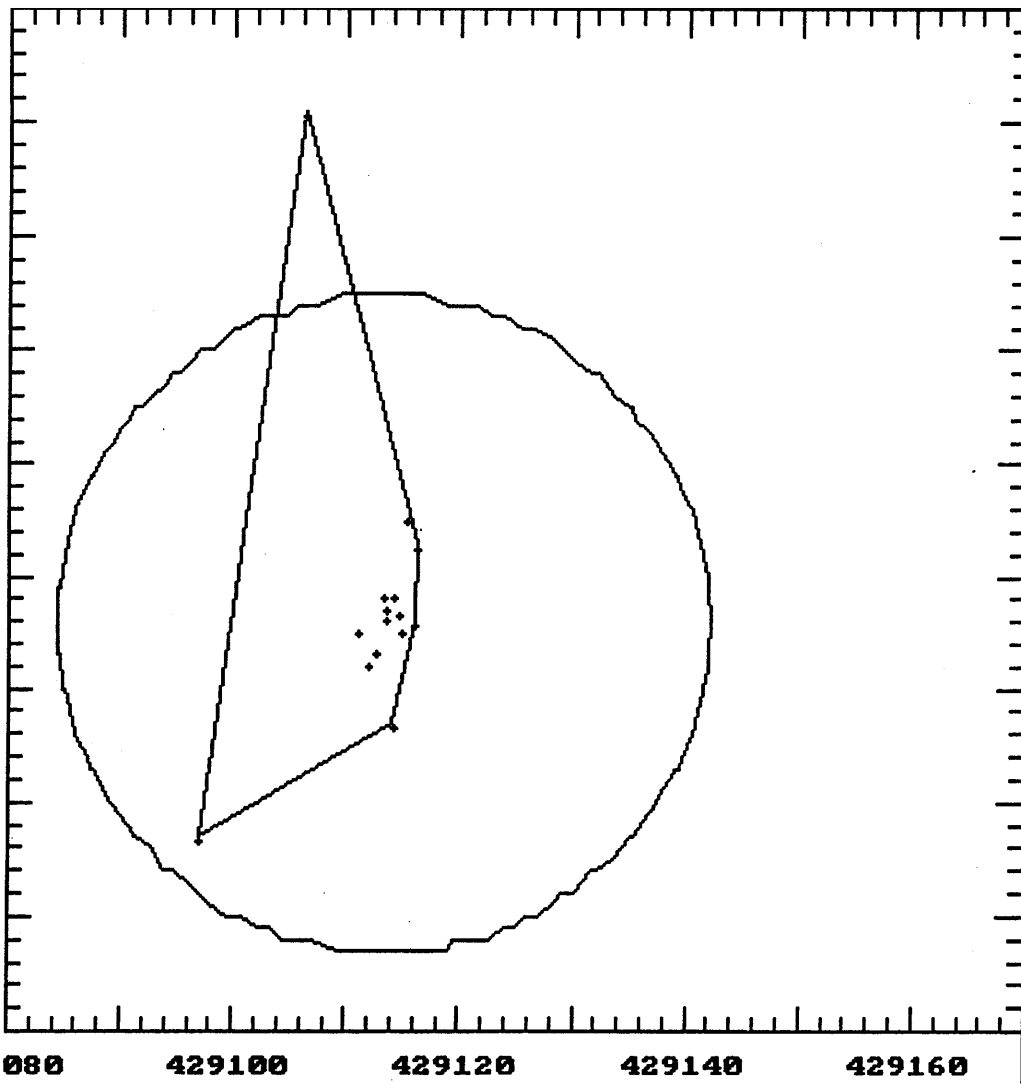

Datafile: DATA350.TXT
Output File: RS350.OUT
Display Units: meters
Adaptive Kernel
95P% 2628.000 m²
Min Convex Polygon
95P% 630.7000 m²
of data points: 15
Xmin: 429096.9
Xmax: 429116.3
Ymin: 4400377.
Ymax: 4400441.
Grid Size: 3.2 m
Avg. Dist: 10.8 m
Bandwidth: 50.0 m
LSCU score: -5244.8

Datafile: DATA386.TXT
Output File: RS386.OUT
Display Units: meters
Adaptive Kernel
95% 8158.000 m²
Min Convex Polygon
95% 10730.00 m²
of data points: 13
Xmin: 429076.8
Xmax: 429176.8
Ymin: 4400358.
Ymax: 4400623.
Grid Size: 13.2 m
Avg. Dist: 40.5 m
Bandwidth: 50.0 m
LSCV score: -.63850E+06

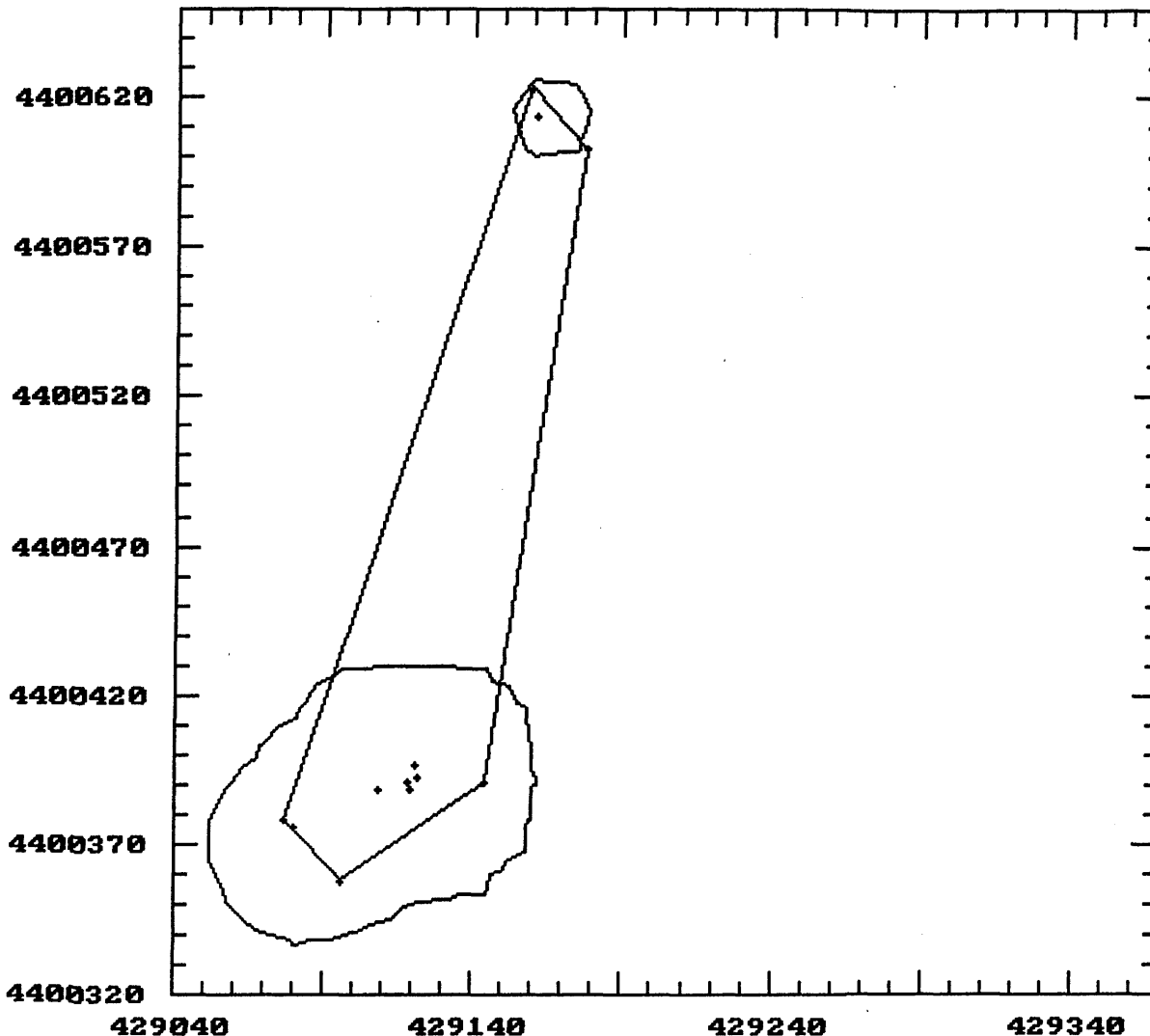

Datafile: DATA471.TXT
Output File: RS471.OUT
Display Units: meters
Adaptive Kernel
95P% 1893.000 m²
Min Convex Polygon
95P% 538.6000 m²
of data points: 10
Xmin: 429968.2
Xmax: 430006.3
Ymin: 4401954.
Ymax: 4401983.
Grid Size: 1.9 m
Avg. Dist: 19.4 m
Bandwidth: 50.0 m
LSCU score: -588.54

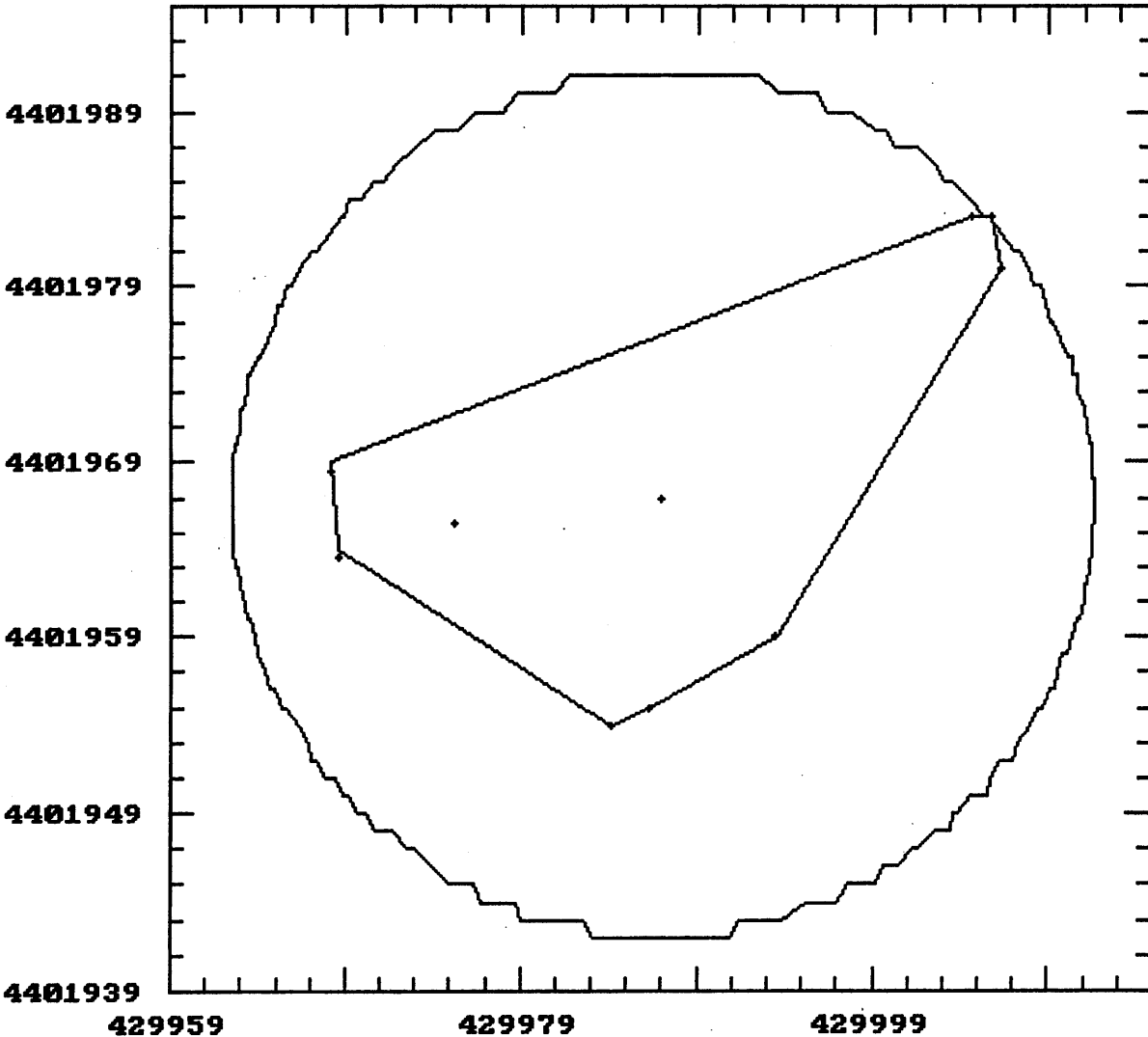

Datafile: DATA476.TXT
Output File: RS476.OUT
Display Units: meters
Adaptive Kernel
95P% 10310.00 m²
Min Convex Polygon
95P% 3829.000 m²
of data points: 14
Xmin: 427986.1
Xmax: 428125.5
Ymin: 4399913.
Ymax: 4399971.
Grid Size: 6.9 m
Avg. Dist: 28.6 m
Bandwidth: 50.0 m
LSCU score: -25209.

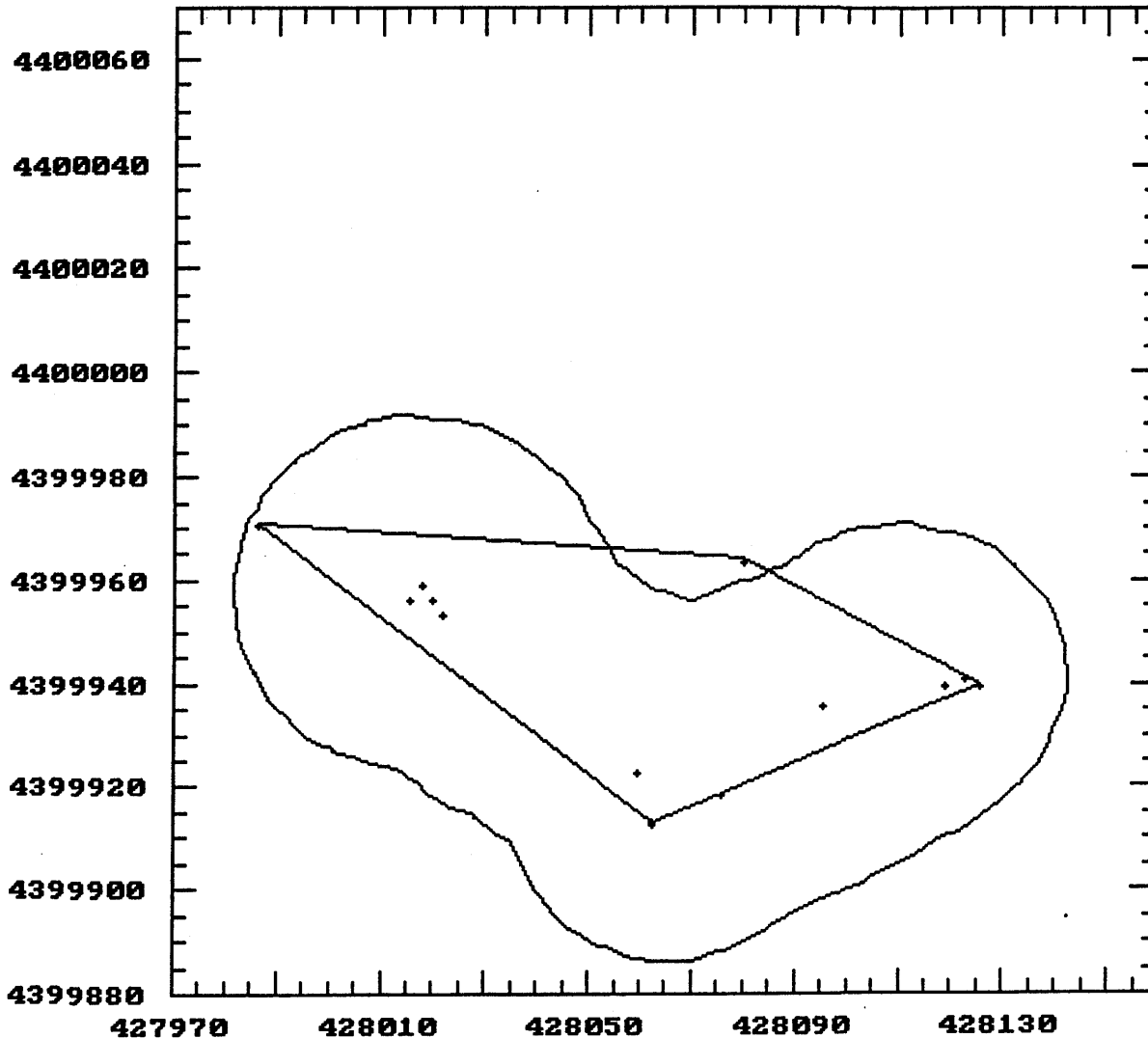

Datafile: DATA482.TXT
Output File: RS482.OUT
Display Units: meters
Adaptive Kernel
95P% 31070.00 m²
Min Convex Polygon
95P% 35190.00 m²
of data points: 14
Xmin: 429660.5
Xmax: 430002.0
Ymin: 4401571.
Ymax: 4401986.
Grid Size: 20.7 m
Avg. Dist: 101.1 m
Bandwidth: 50.0 m
LSCV score: -.19405E+07

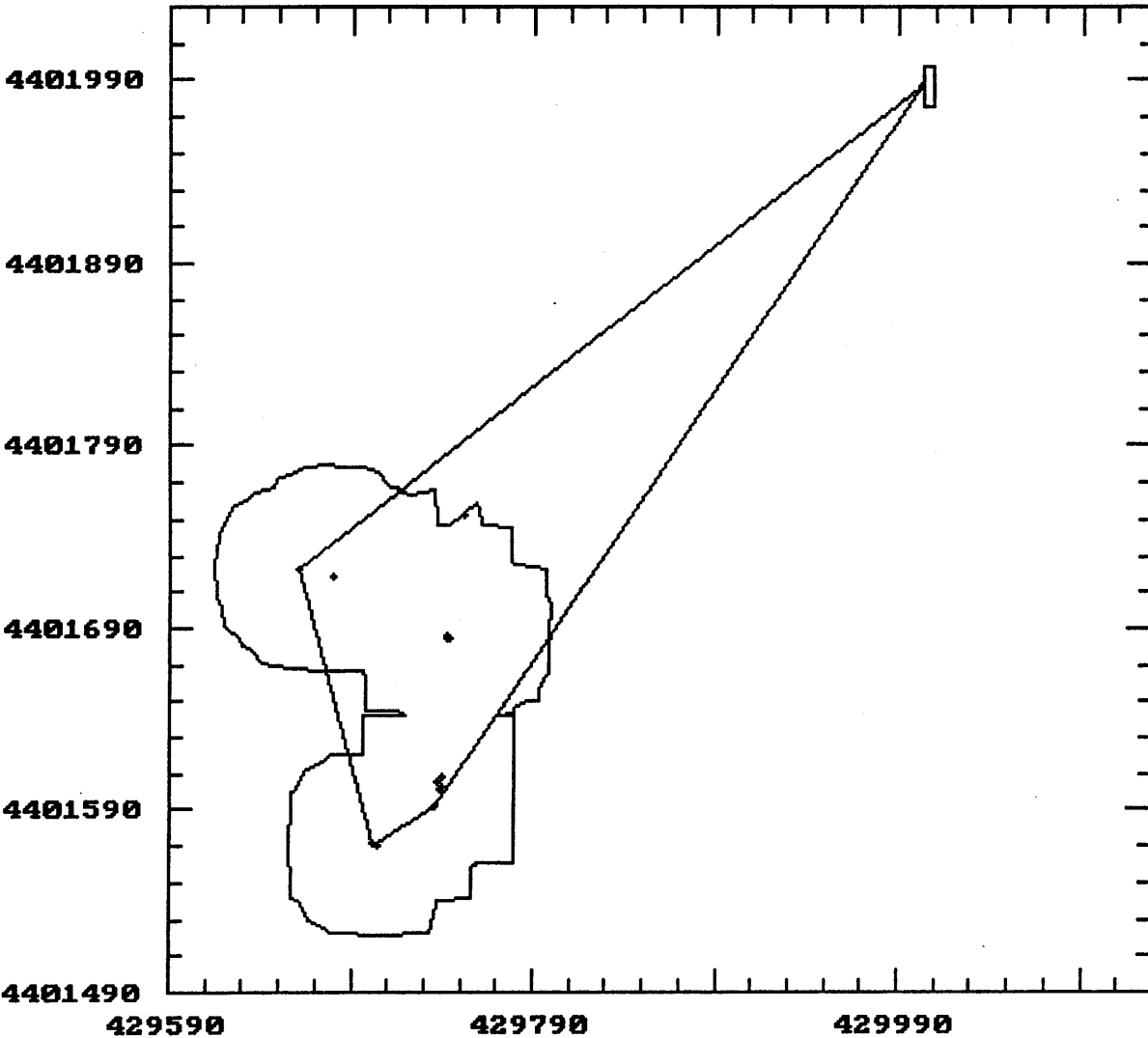

4400080

4400070

4400060

4400050

4400040

4400030

4400020

4400010

4400000

4399990

427800

427820

427840

427860

427880

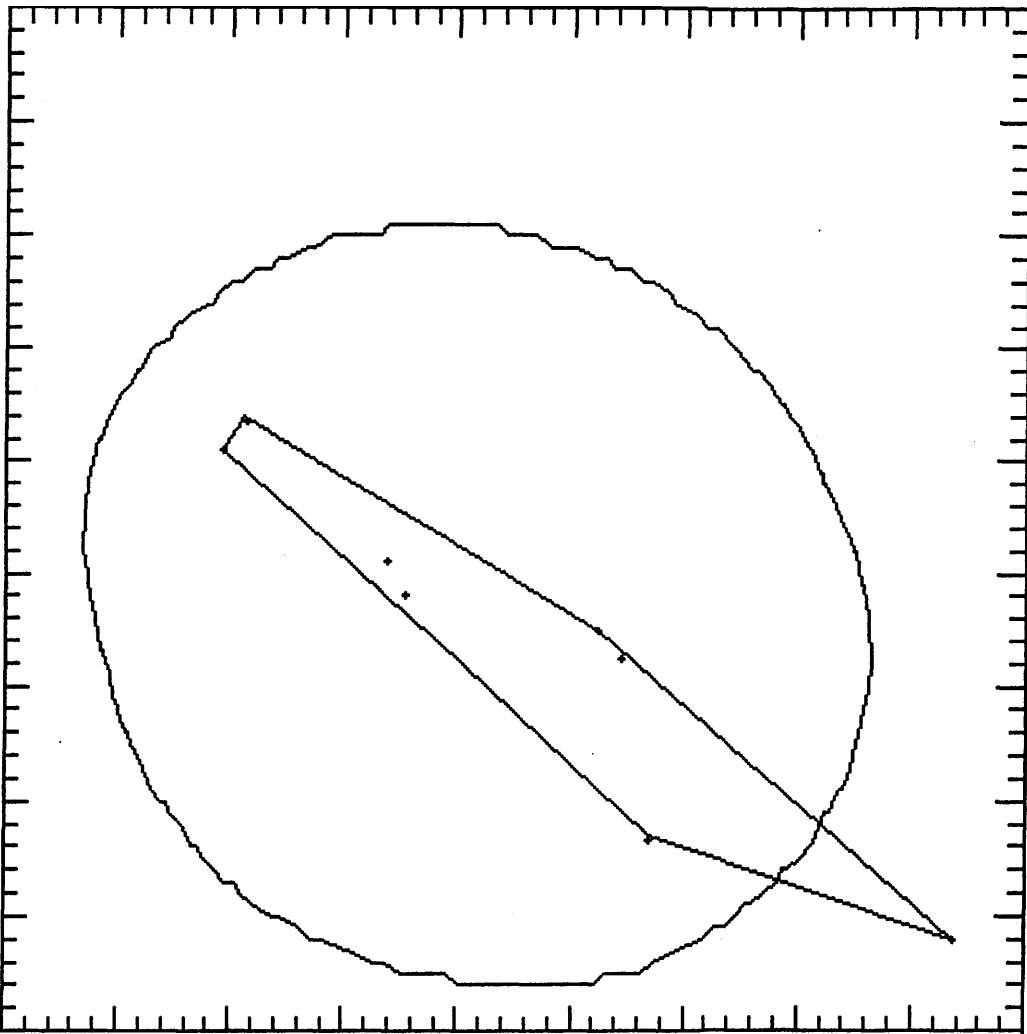

Datafile: DATA487.TXT
 Output File: RS487.OUT
 Display Units: meters
 Adaptive Kernel
 95% 3629.000 m²
 Min Convex Polygon
 95% 554.0000 m²
 # of data points: 8
 Xmin: 427819.2
 Xmax: 427883.6
 Ymin: 4399998.
 Ymax: 4400044.
 Grid Size: 3.2 m
 Avg. Dist: 19.6 m
 Bandwidth: 50.0 m
 LSCU score: -3344.6

4399970

4399950

4399930

4399910

4399890

4399870

4399850

4399830

4399810

427730

427770

427810

427850

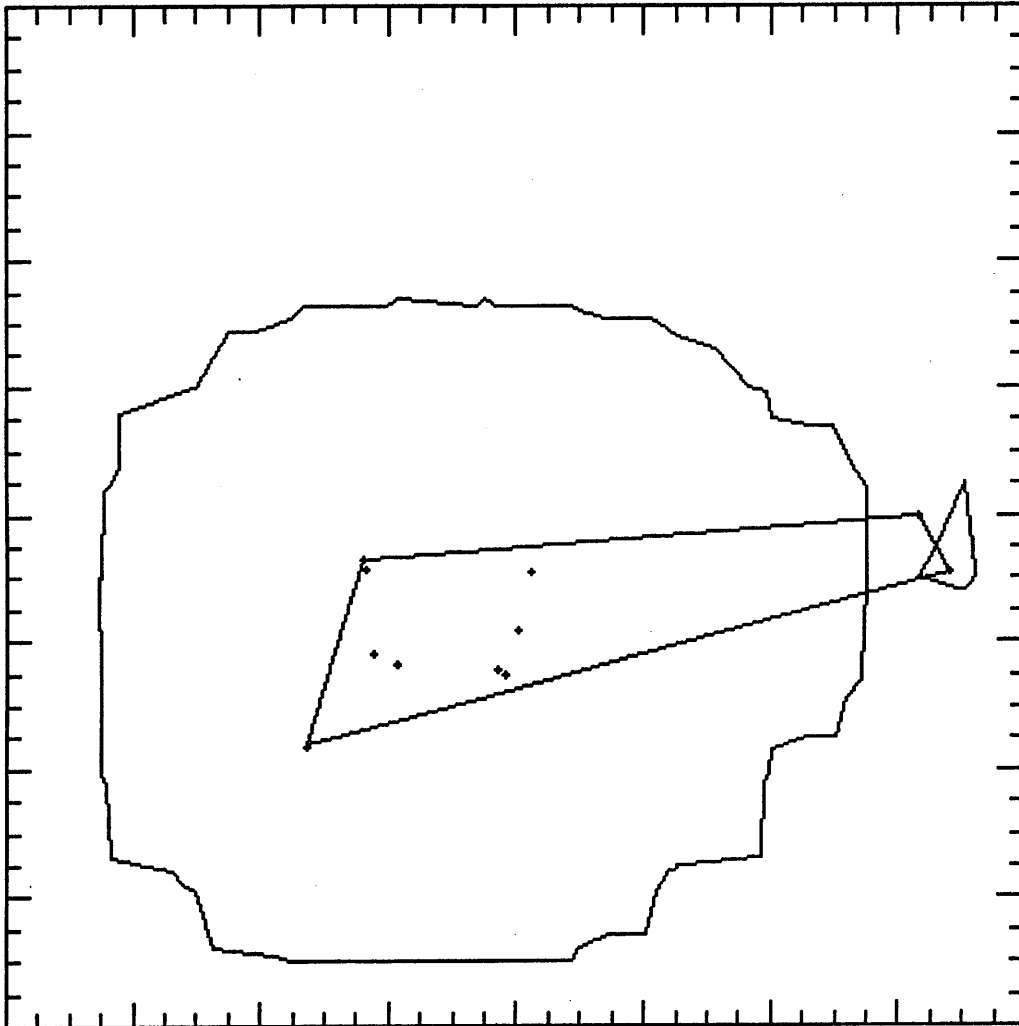

Datafile: DATA490.TXT
Output File: RS490.OUT
Display Units: meters
Adaptive Kernel
95P% 10460.00 m²
Min Convex Polygon
95P% 1768.000 m²
of data points: 11
Xmin: 427777.3
Xmax: 427877.8
Ymin: 4399854.
Ymax: 4399890.
Grid Size: 15.0 m
Avg. Dist: 28.7 m
Bandwidth: 50.0 m
LSCU score: -20998.

Datafile: DATA572.TXT
Output File: RS572.OUT
Display Units: meters
Adaptive Kernel
95P% 2473.000 m²
Min Convex Polygon
95P% 620.7000 m²
of data points: 22
Xmin: 429786.8
Xmax: 429829.8
Ymin: 4401909.
Ymax: 4402055.
Grid Size: 7.3 m
Avg. Dist: 25.2 m
Bandwidth: 50.0 m
LSCU score: -.10898E+06

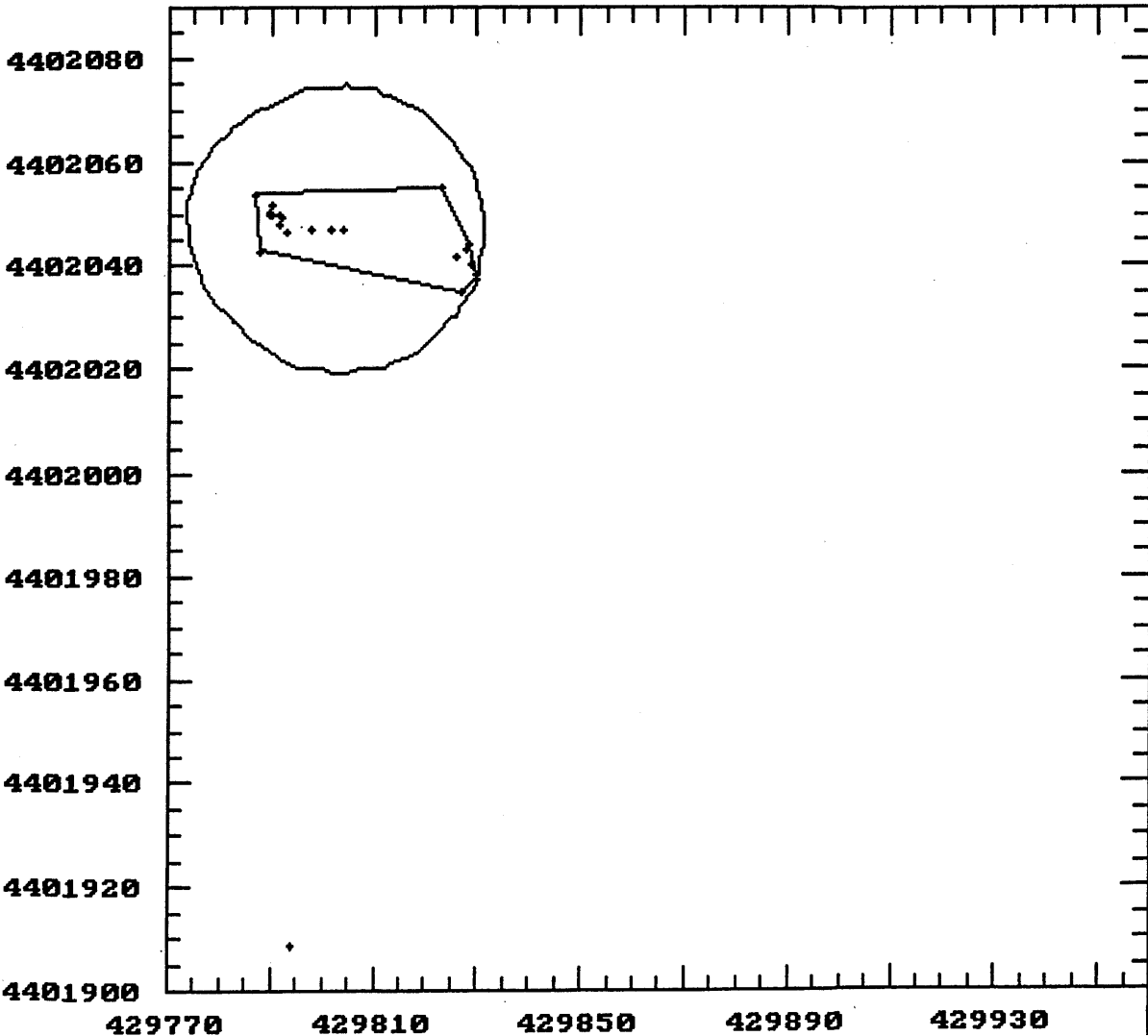

4401940
4401890
4401840
4401790
4401740
4401690
4401640
4401590

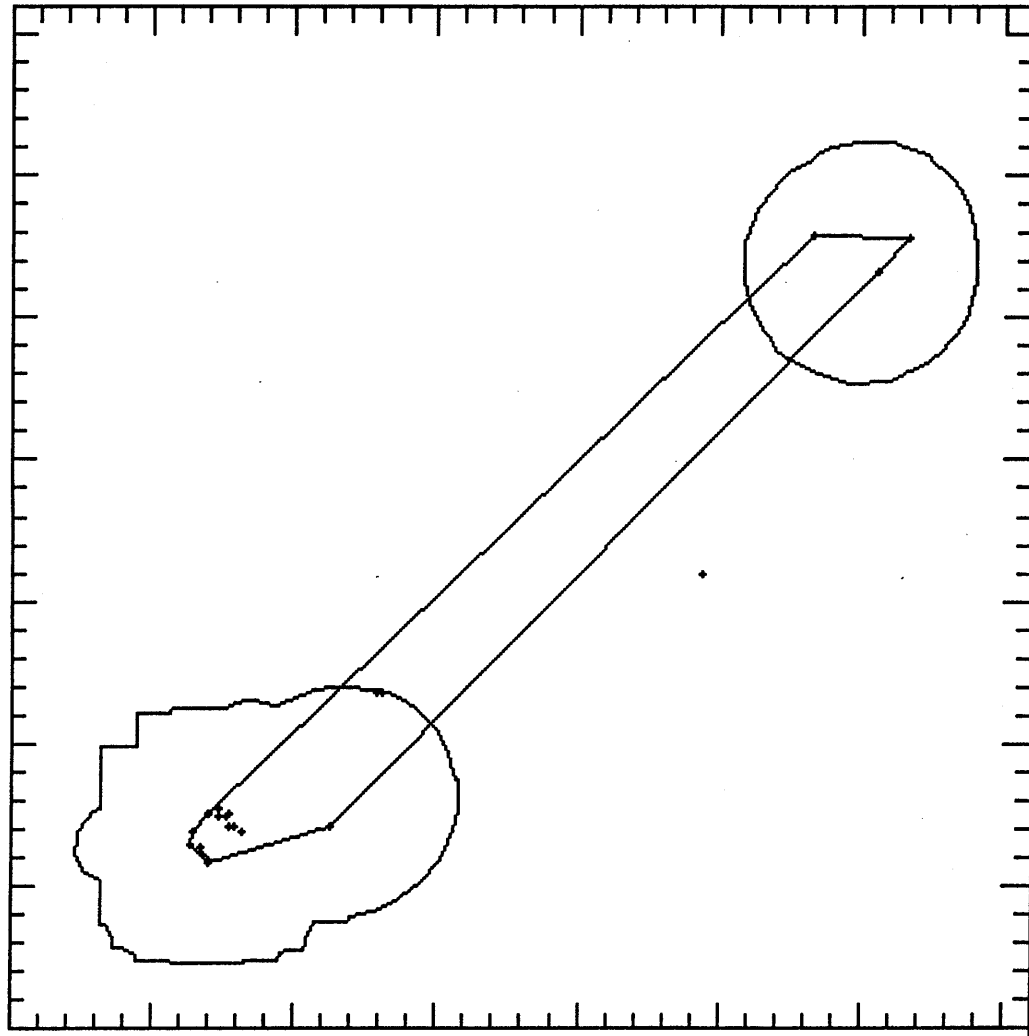

429510 429610 429710 429810

Datafile: DATA574.TXT
Output File: RS574.OUT
Display Units: meters
Adaptive Kernel
95% 15500.00 m²
Min Convex Polygon
95% 8916.000 m²
of data points: 23
Xmin: 429573.1
Xmax: 429826.2
Ymin: 4401648.
Ymax: 4401869.
Grid Size: 12.6 m
Avg. Dist: 32.1 m
Bandwidth: 50.0 m
LSCU score: -.10693E+07

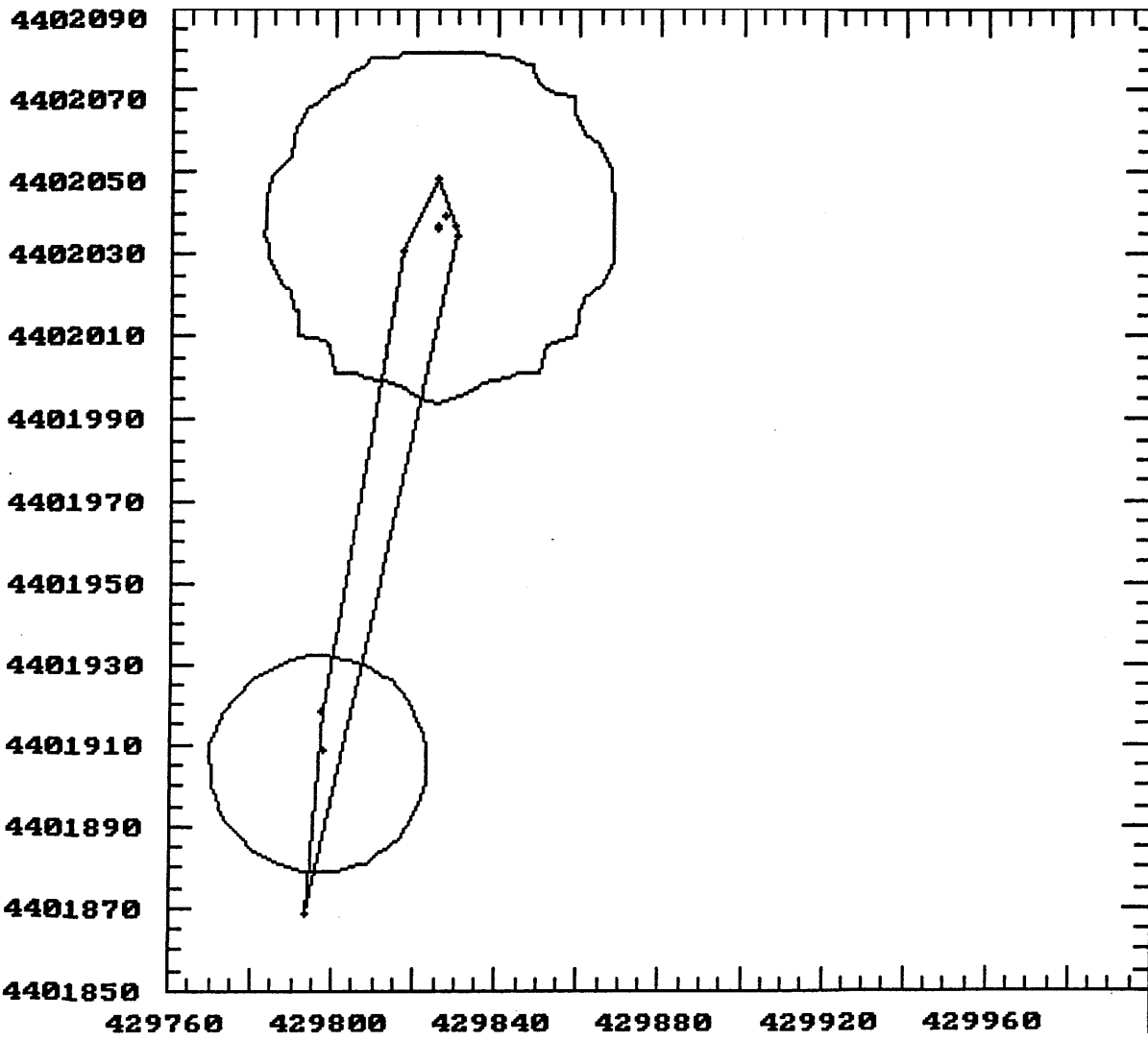

Datafile: DATA576.TXT
Output File: RS576.OUT
Display Units: meters
Adaptive Kernel
95P% 7826.000 m²
Min Convex Polygon
95P% 1383.000 m²
of data points: 10
Xmin: 429793.1
Xmax: 429830.1
Ymin: 4401869.
Ymax: 4402048.
Grid Size: 8.9 m
Avg. Dist: 25.9 m
Bandwidth: 50.0 m
LSCU score: -.22772E+06

Datafile: DATA577.TXT
Output File: RS577.OUT
Display Units: meters
Adaptive Kernel
95P% 11990.00 m²
Min Convex Polygon
95P% 7444.000 m²
of data points: 11
Xmin: 429709.2
Xmax: 429787.3
Ymin: 4401623.
Ymax: 4401872.
Grid Size: 12.4 m
Avg. Dist: 54.1 m
Bandwidth: 50.0 m
LSCU score: -.83284E+06

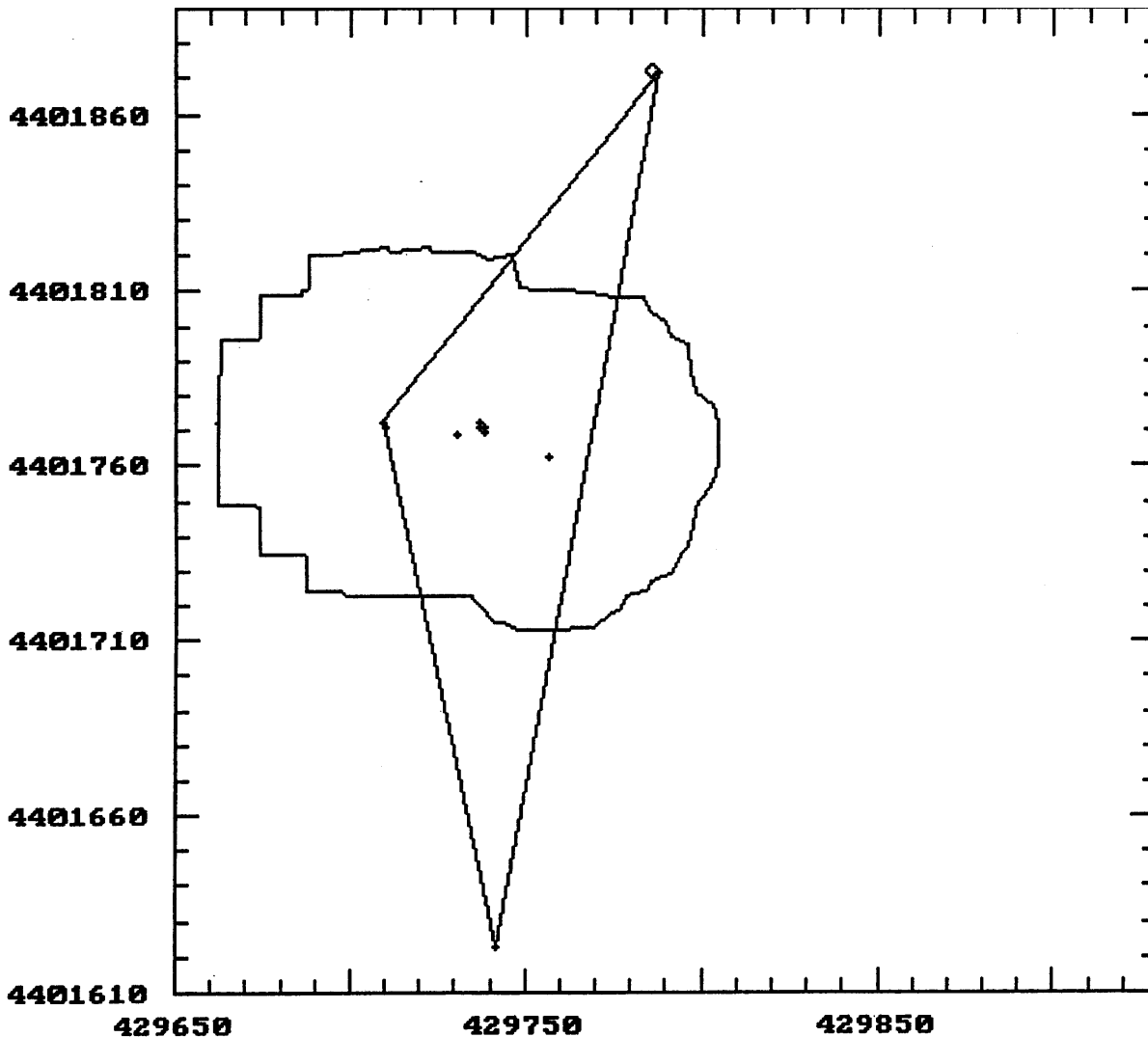

Datafile: DATA578.TXT
Output File: RS578.OUT
Display Units: meters
Adaptive Kernel
95% 10160.00 m²
Min Convex Polygon
95% 15450.00 m²
of data points: 12
Xmin: 427856.7
Xmax: 428141.8
Ymin: 4399870.
Ymax: 4400010.
Grid Size: 14.2 m
Avg. Dist: 39.9 m
Bandwidth: 50.0 m
LSCU score: $-.97596E+06$

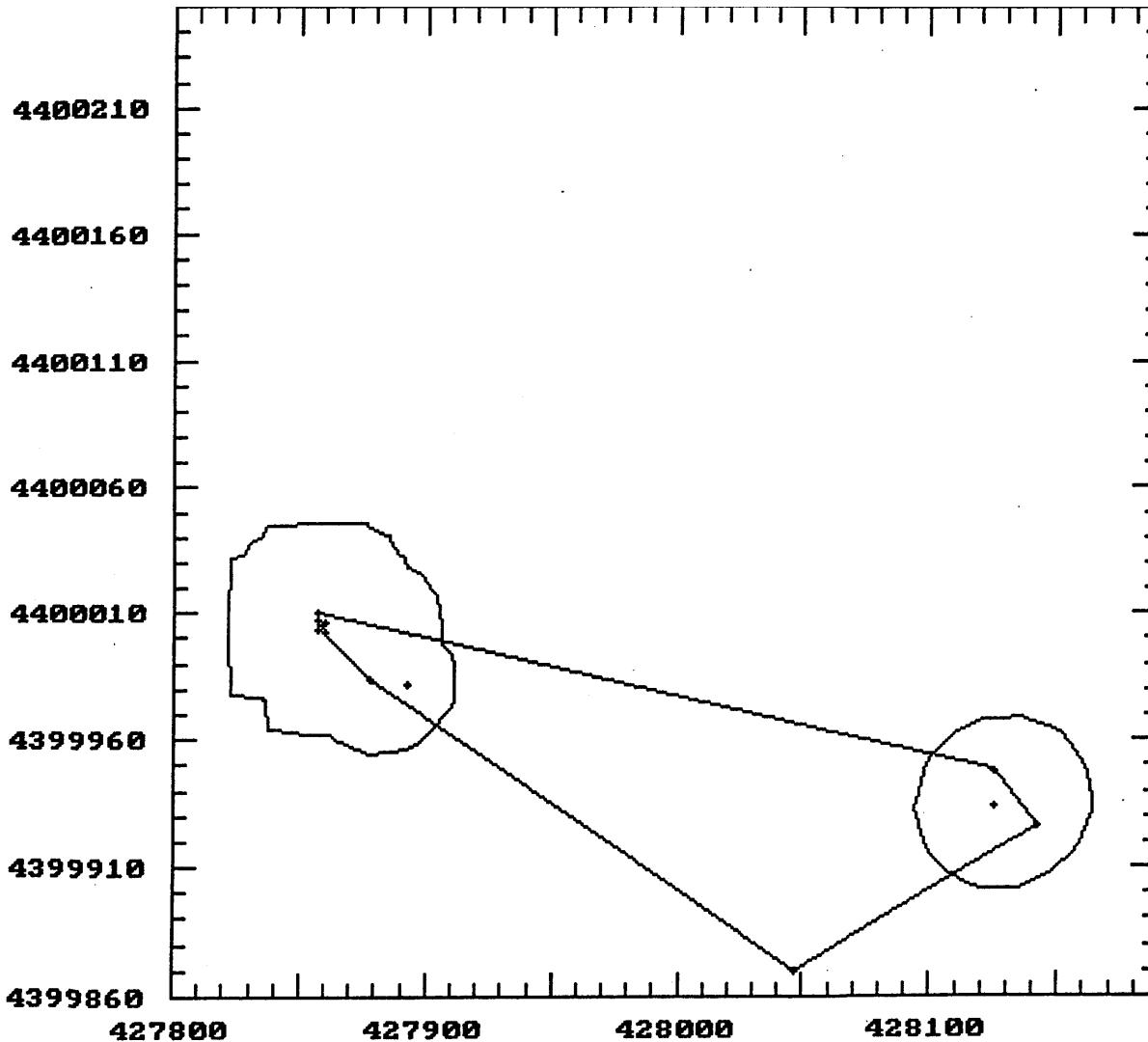

4402090

4402070

4402050

4402030

4402010

4401990

4401970

4401950

4401930

4401910

4401890

4401870

4401850

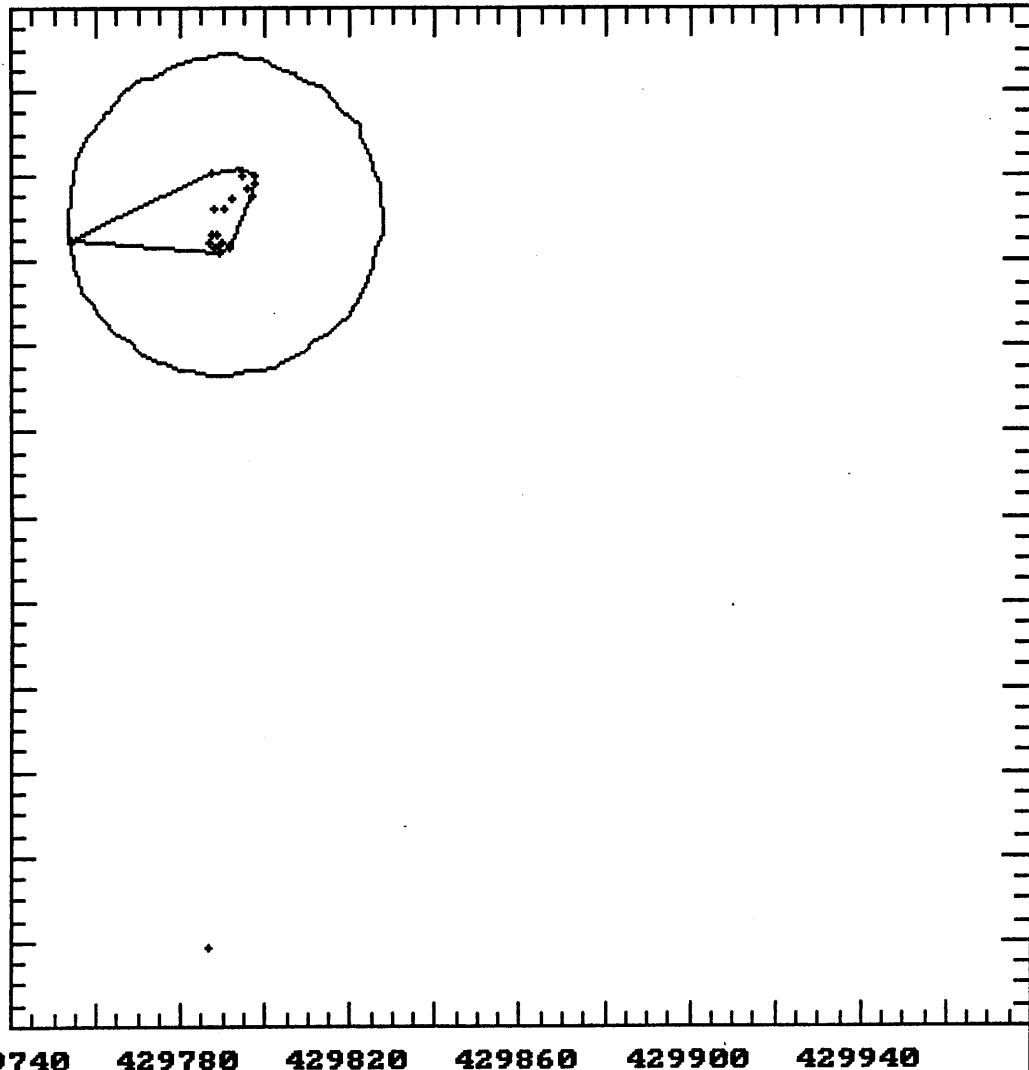

Datafile: DATA579.TXT
 Output File: RS579.OUT
 Display Units: meters
 Adaptive Kernel
 95P% 4384.000 m²
 Min Convex Polygon
 95P% 460.8000 m²
 # of data points: 22
 Xmin: 429753.9
 Xmax: 429797.3
 Ymin: 4401869.
 Ymax: 4402052.
 Grid Size: 9.1 m
 Avg. Dist: 18.4 m
 Bandwidth: 50.0 m
 LSCU score: -.34264E+06

429740 429780 429820 429860 429900 429940

4402100
4402050
4402000
4401950
4401900
4401850

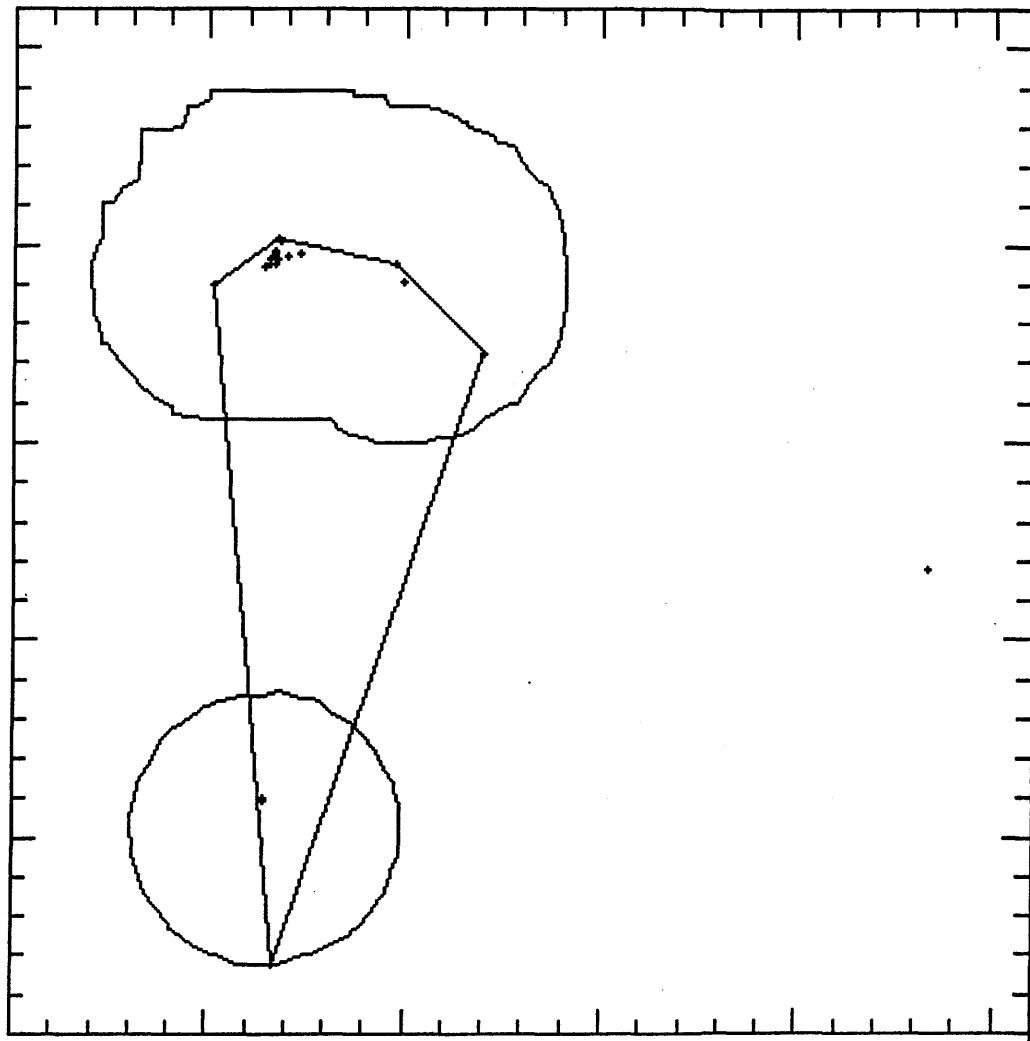

429730 429830 429930

Datafile: DATA580.TXT
Output File: RS580.OUT
Display Units: meters
Adaptive Kernel
95P% 12460.00 m²
Min Convex Polygon
95P% 6659.000 m²
of data points: 20
Xmin: 429780.8
Xmax: 429962.9
Ymin: 4401868.
Ymax: 4402052.
Grid Size: 9.2 m
Avg. Dist: 35.6 m
Bandwidth: 50.0 m
LSCU score: -.29215E+06

Datafile: DATA581.TXT
Output File: RS581.OUT
Display Units: meters
Adaptive Kernel
95P% 14130.00 m²
Min Convex Polygon
95P% 9275.000 m²
of data points: 10
Xmin: 429786.6
Xmax: 429846.5
Ymin: 4401887.
Ymax: 4402286.
Grid Size: 19.9 m
Avg. Dist: 54.0 m
Bandwidth: 50.0 m
LSCU score: -.26963E+07

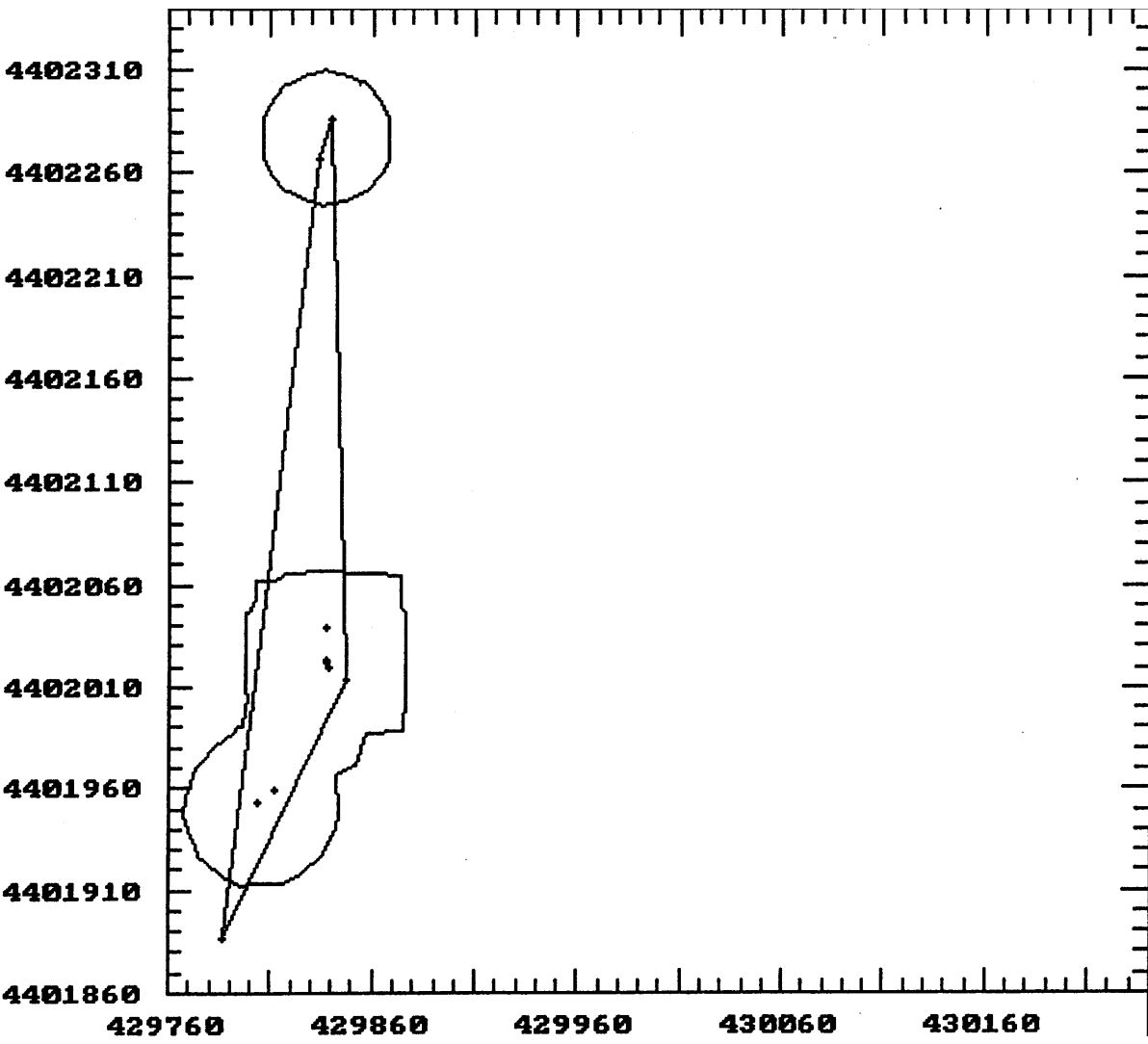

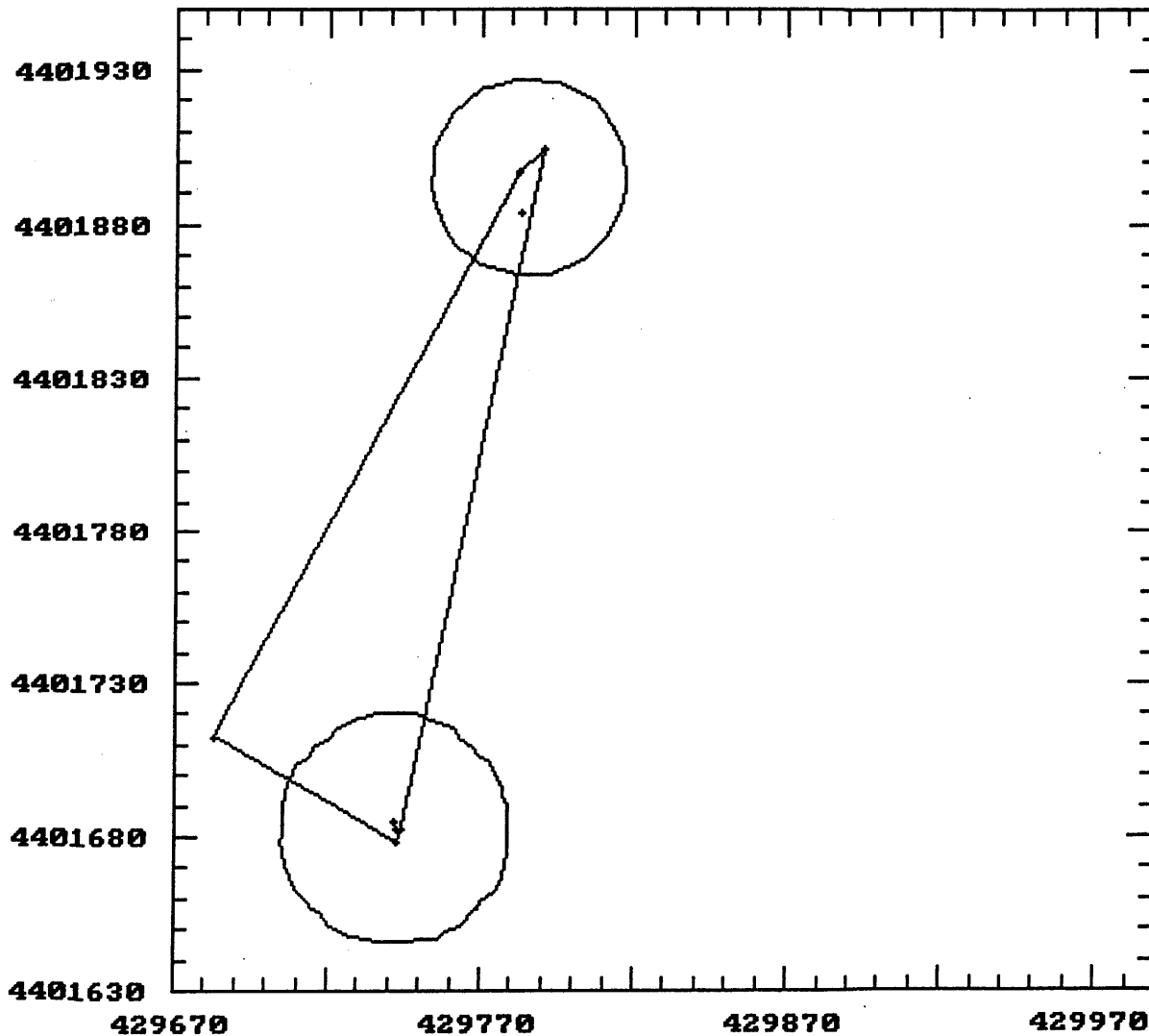

Datafile: DATA582.TXT
 Output File: RS582.OUT
 Display Units: meters
 Adaptive Kernel
 95P% 7533.000 m²
 Min Convex Polygon
 95P% 8068.000 m²
 # of data points: 8
 Xmin: 429682.6
 Xmax: 429790.3
 Ymin: 4401678.
 Ymax: 4401904.
 Grid Size: 11.3 m
 Avg. Dist: 46.9 m
 Bandwidth: 50.0 m
 LSCU score: -.30251E+06

Datafile: DATA583.TXT
Output File: RS583.OUT
Display Units: meters
Adaptive Kernel
95% 11140.00 m²
Min Convex Polygon
95% 3593.000 m²
of data points: 19
Xmin: 429788.4
Xmax: 429975.9
Ymin: 4401901.
Ymax: 4402000.
Grid Size: 9.3 m
Avg. Dist: 19.2 m
Bandwidth: 50.0 m
LSCU score: $-.37894E+06$

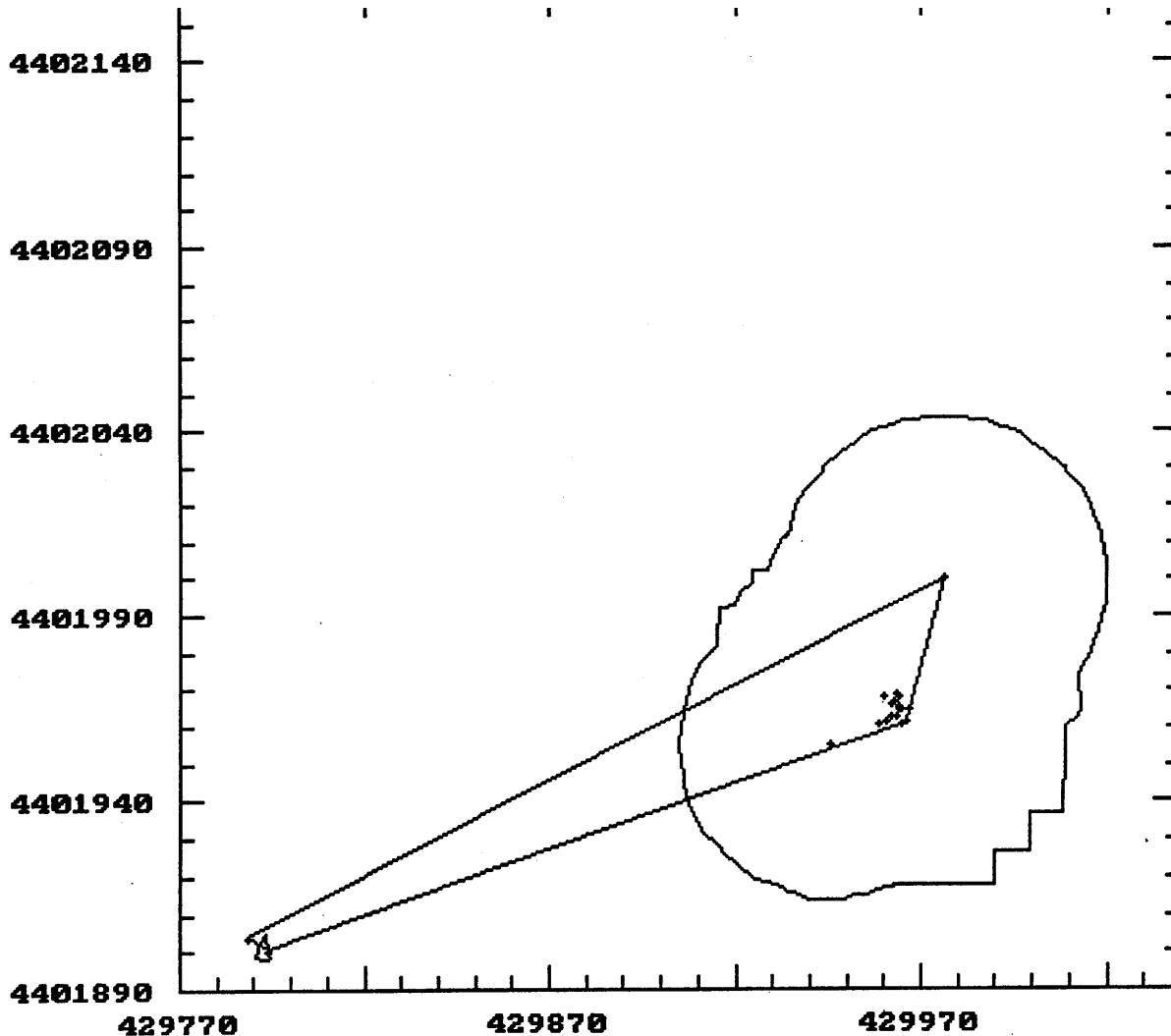

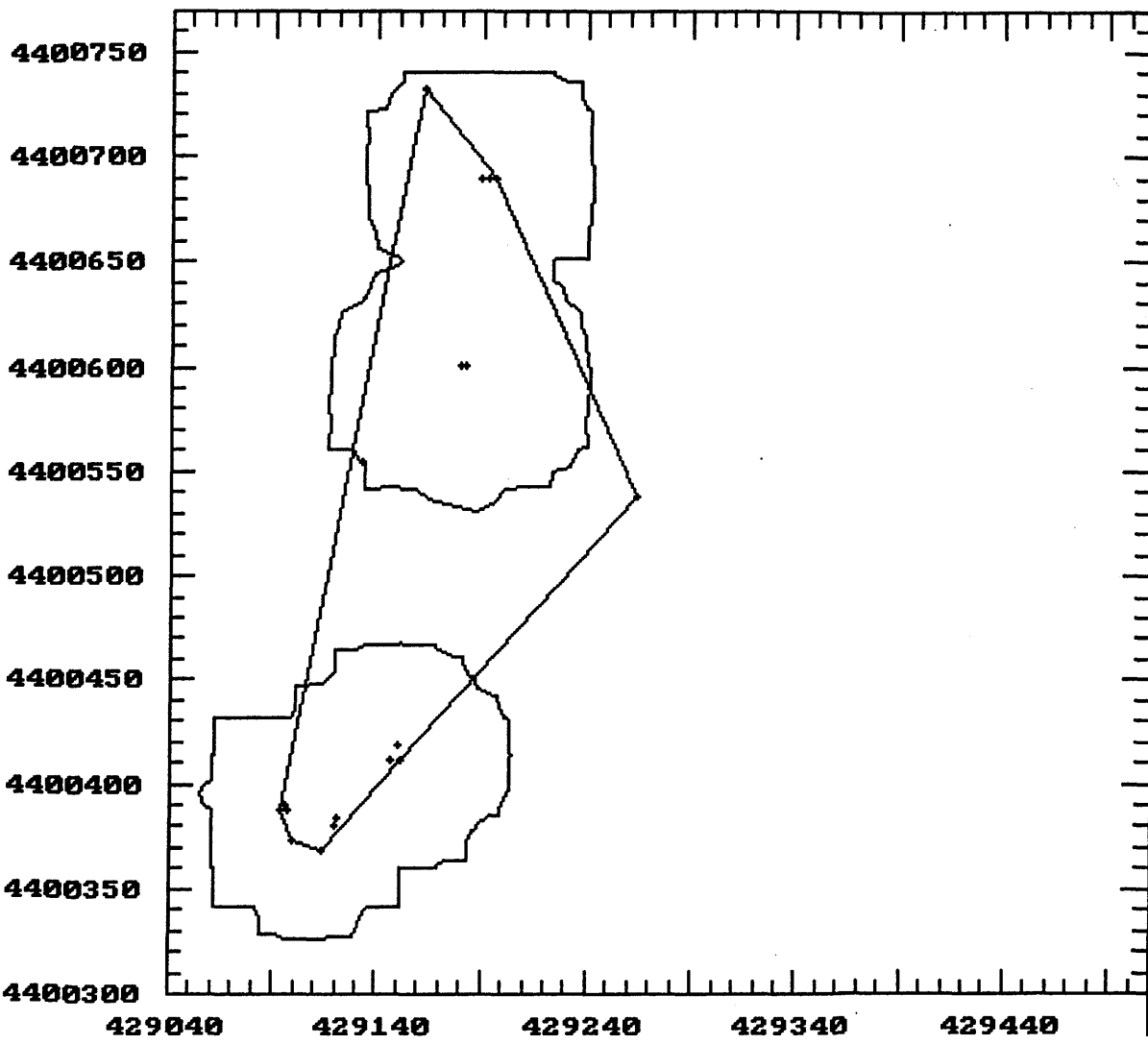

Datafile: DATA585.TXT
Output File: RS585.OUT
Display Units: meters
Adaptive Kernel
95P% 36310.00 m²
Min Convex Polygon
95P% 28400.00 m²
of data points: 18
Xmin: 429093.7
Xmax: 429263.4
Ymin: 4400369.
Ymax: 4400732.
Grid Size: 18.1 m
Avg. Dist: 70.2 m
Bandwidth: 50.0 m
LSCU score: -.11331E+07

Datafile: DATA587.TXT
Output File: RS587.OUT
Display Units: meters
Adaptive Kernel
95% 45.95000 ha ———
Min Convex Polygon
95% 19.50000 ha ———
of data points: 11
Xmin: 428725.5
Xmax: 429744.0
Ymin: 4400025.
Ymax: 4401683.
Grid Size: 82.8 m
Avg. Dist: 209.5 m
Bandwidth: 505.7 m
LSCU score: -.10066E+08

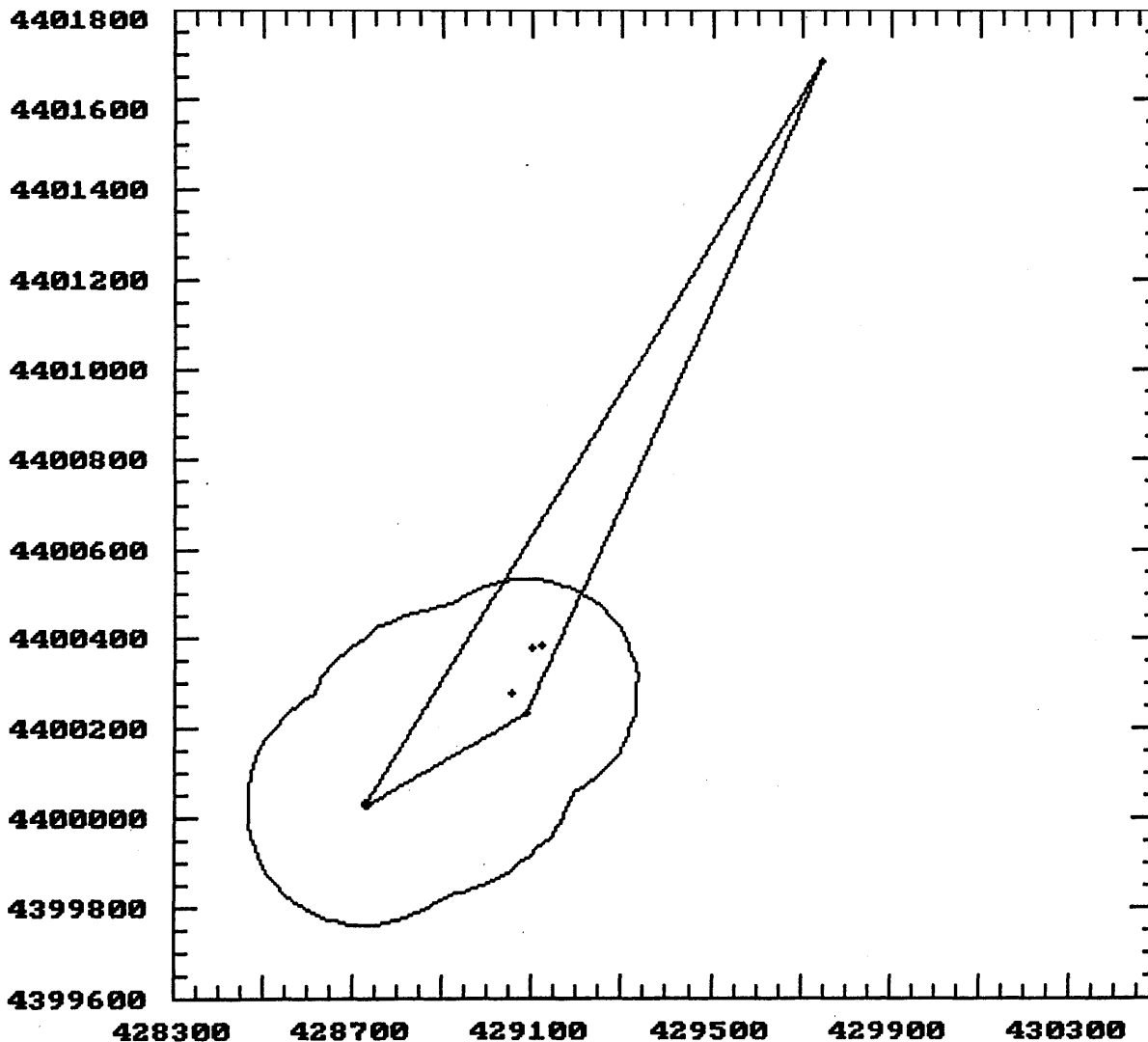

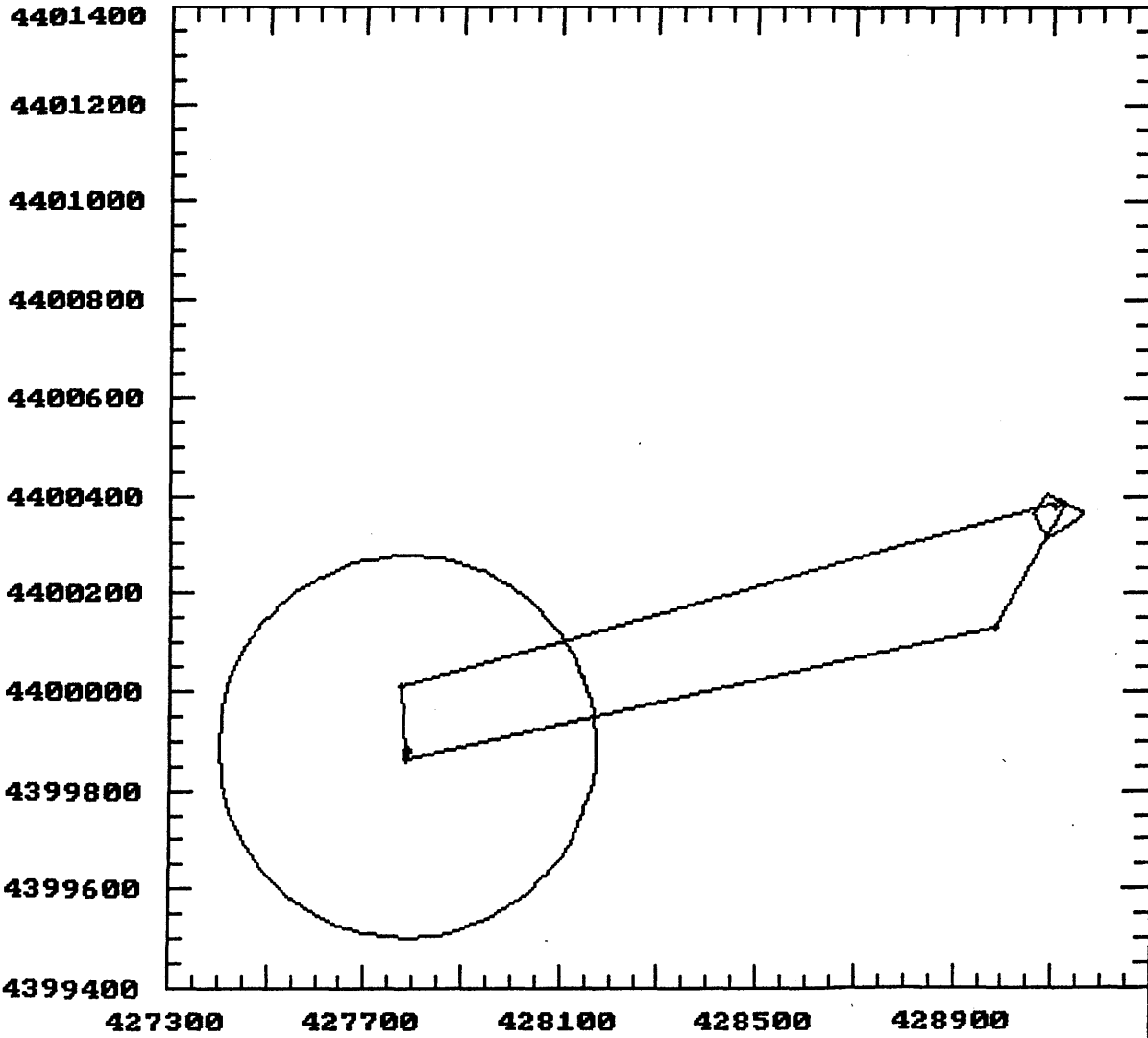

Datafile: DATA588.TXT
Output File: RS588.OUT
Display Units: meters
Adaptive Kernel
93% 47.41000 ha ———
Min Convex Polygon
95% 24.07000 ha ———
of data points: 17
Xmin: 427771.1
Xmax: 429122.9
Ymin: 4399864.
Ymax: 4400389.
Grid Size: 67.5 m
Avg. Dist: 140.0 m
Bandwidth: 571.3 m
LSCU score: -.43085E+07

Datafile: DATA589.TXT
Output File: RS589.OUT
Display Units: meters
Adaptive Kernel

95P% 20040.00 m²

Min Convex Polygon

95P% 13560.00 m²

of data points: 18

Xmin: 429089.8

Xmax: 429214.4

Ymin: 4400377.

Ymax: 4400633.

Grid Size: 12.8 m

Avg. Dist: 40.8 m

Bandwidth: 50.0 m

LSCV score: $-.30366E+06$

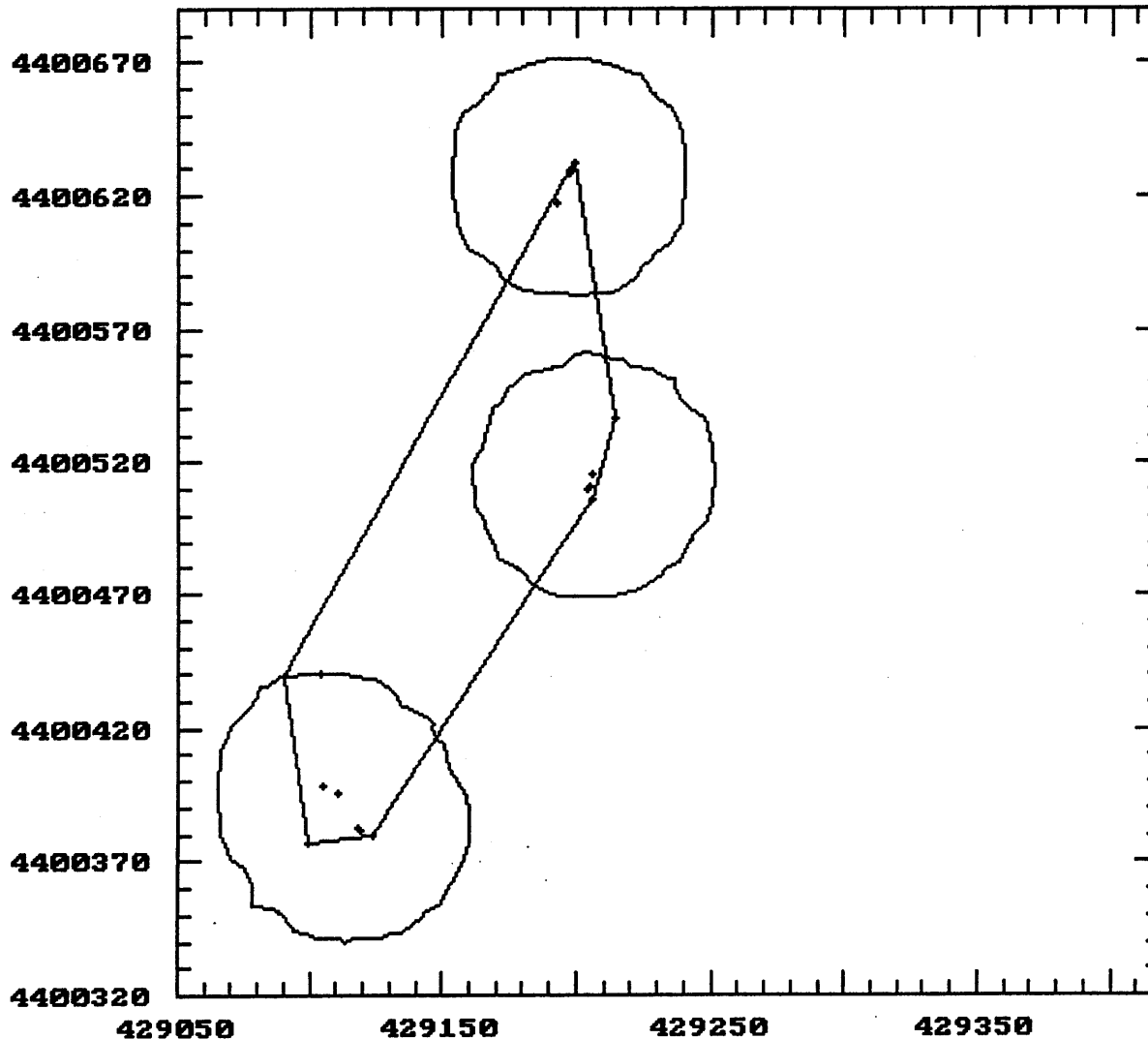

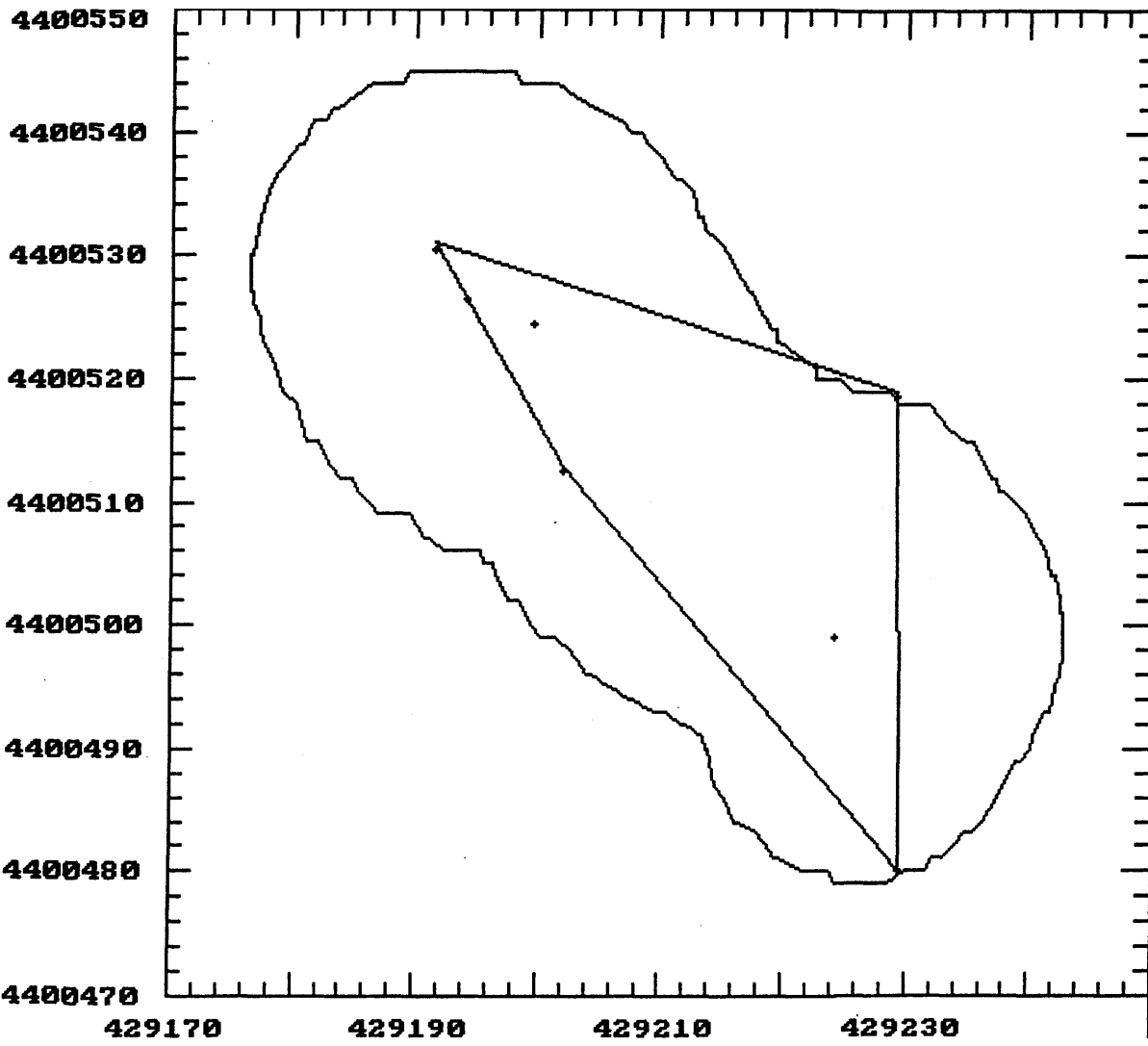

Datafile: DATA590.TXT
Output File: RS590.OUT
Display Units: meters
Adaptive Kernel
95P% 2387.000 m²
Min Convex Polygon
95P% 802.9000 m²
of data points: 7
Xmin: 429191.6
Xmax: 429229.4
Ymin: 4400480.
Ymax: 4400531.
Grid Size: 3.0 m
Avg. Dist: 29.7 m
Bandwidth: 24.5 m
LSCV score: -2077.4

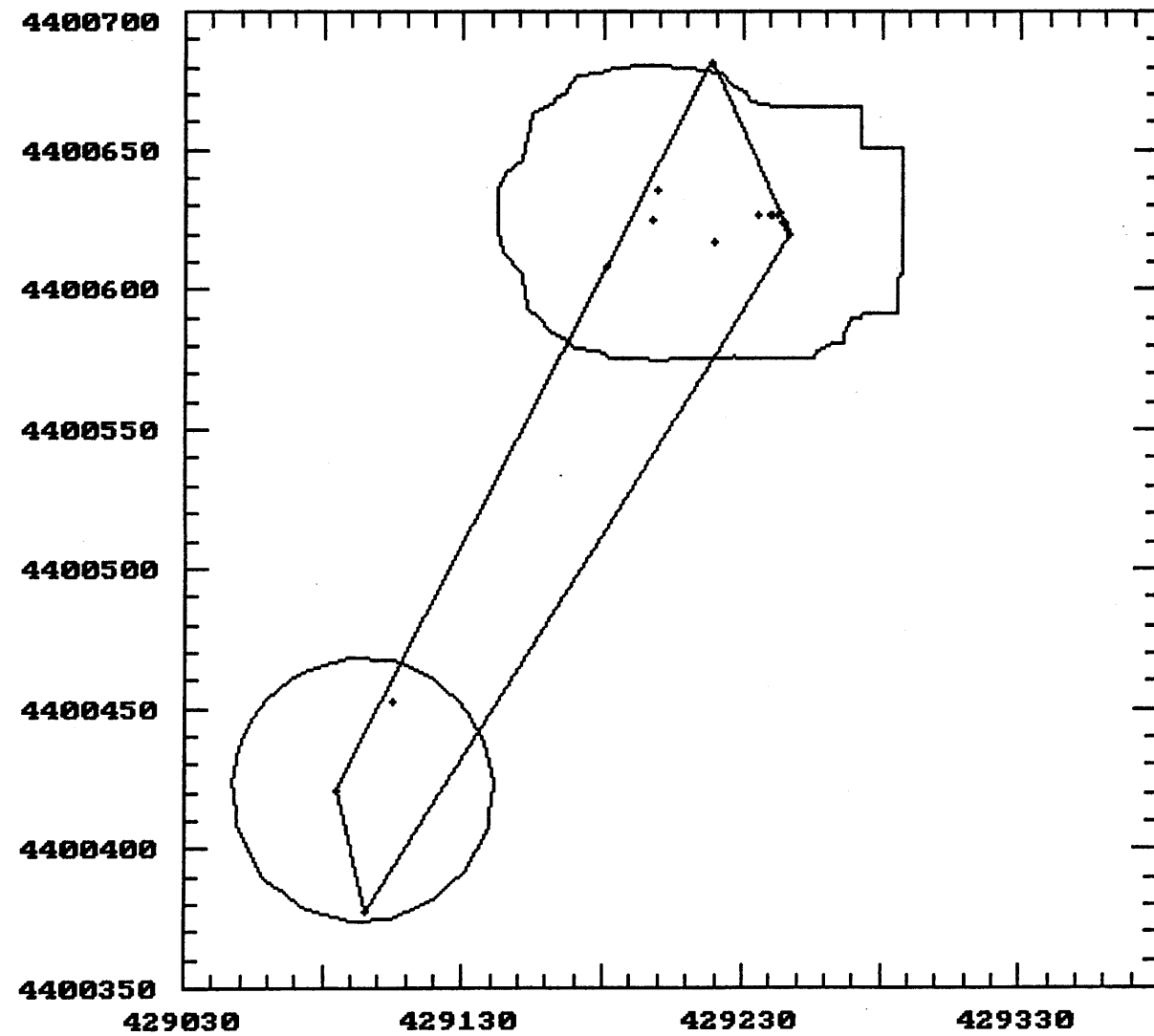

Datafile: DATA592.TXT
Output File: RS592.OUT
Display Units: meters
Adaptive Kernel
95P% 19350.00 m²
Min Convex Polygon
95P% 12420.00 m²
of data points: 18
Xmin: 429084.5
Xmax: 429246.9
Ymin: 4400377.
Ymax: 4400682.
Grid Size: 15.2 m
Avg. Dist: 46.6 m
Bandwidth: 50.0 m
LSCU score: $-.17921E+07$

Datafile: DATA771.TXT
Output File: RS771.OUT
Display Units: meters
Adaptive Kernel

95% 4988.000 m²

Min Convex Polygon

95% 828.9000 m²

of data points: 6

Xmin: 429707.8

Xmax: 429787.5

Ymin: 4401772.

Ymax: 4401873.

Grid Size: 5.0 m

Avg. Dist: 35.3 m

Bandwidth: 40.0 m

LSCU score: -16287.

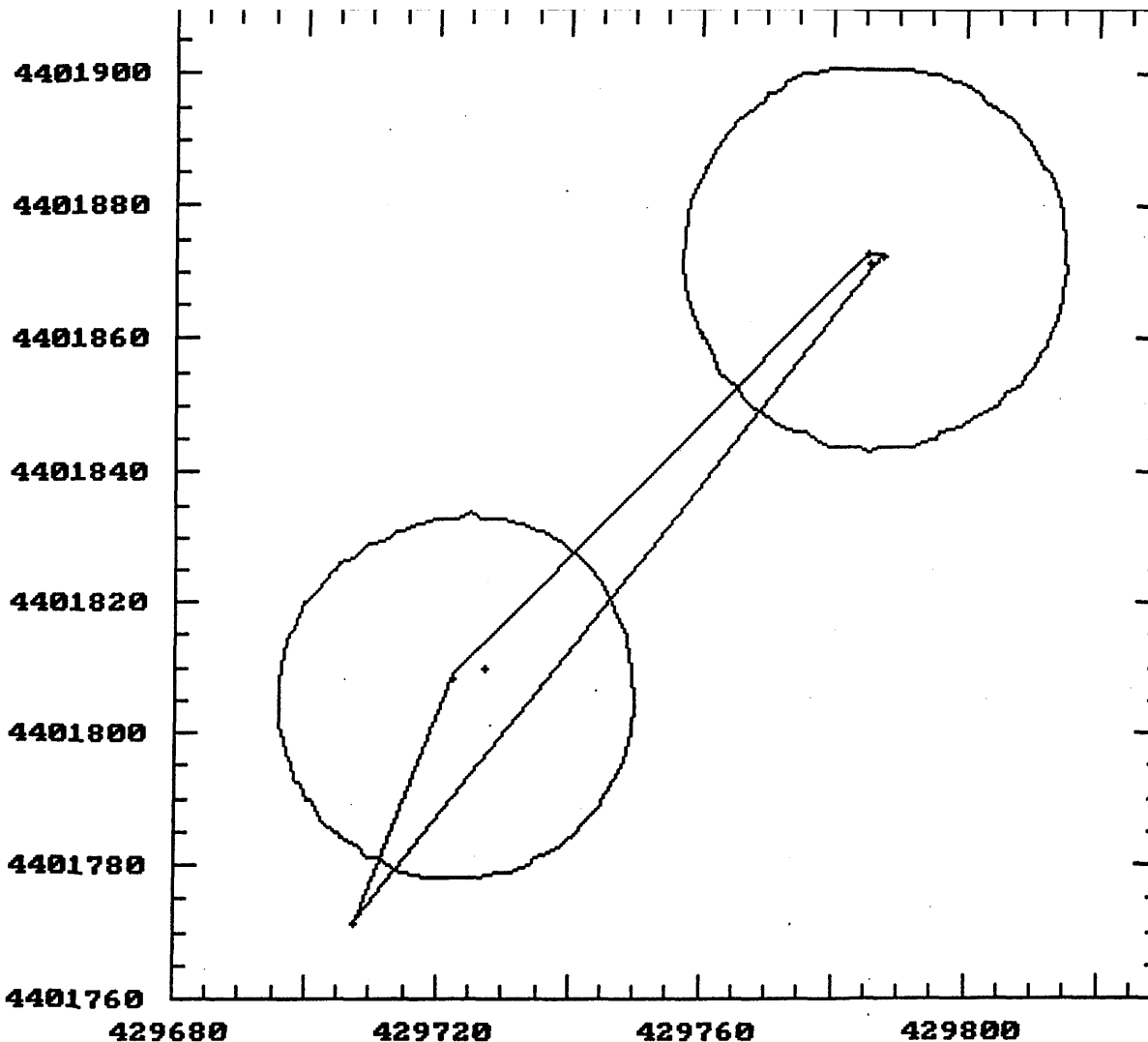

Datafile: DATA773.TXT
Output File: RS773.OUT
Display Units: meters
Adaptive Kernel
95% 6229.000 m²
Min Convex Polygon
95% 3182.000 m²
of data points: 10
Xmin: 429788.3
Xmax: 429833.9
Ymin: 4401897.
Ymax: 4402029.
Grid Size: 6.5 m
Avg. Dist: 24.3 m
Bandwidth: 50.0 m
LSCV score: -45520.

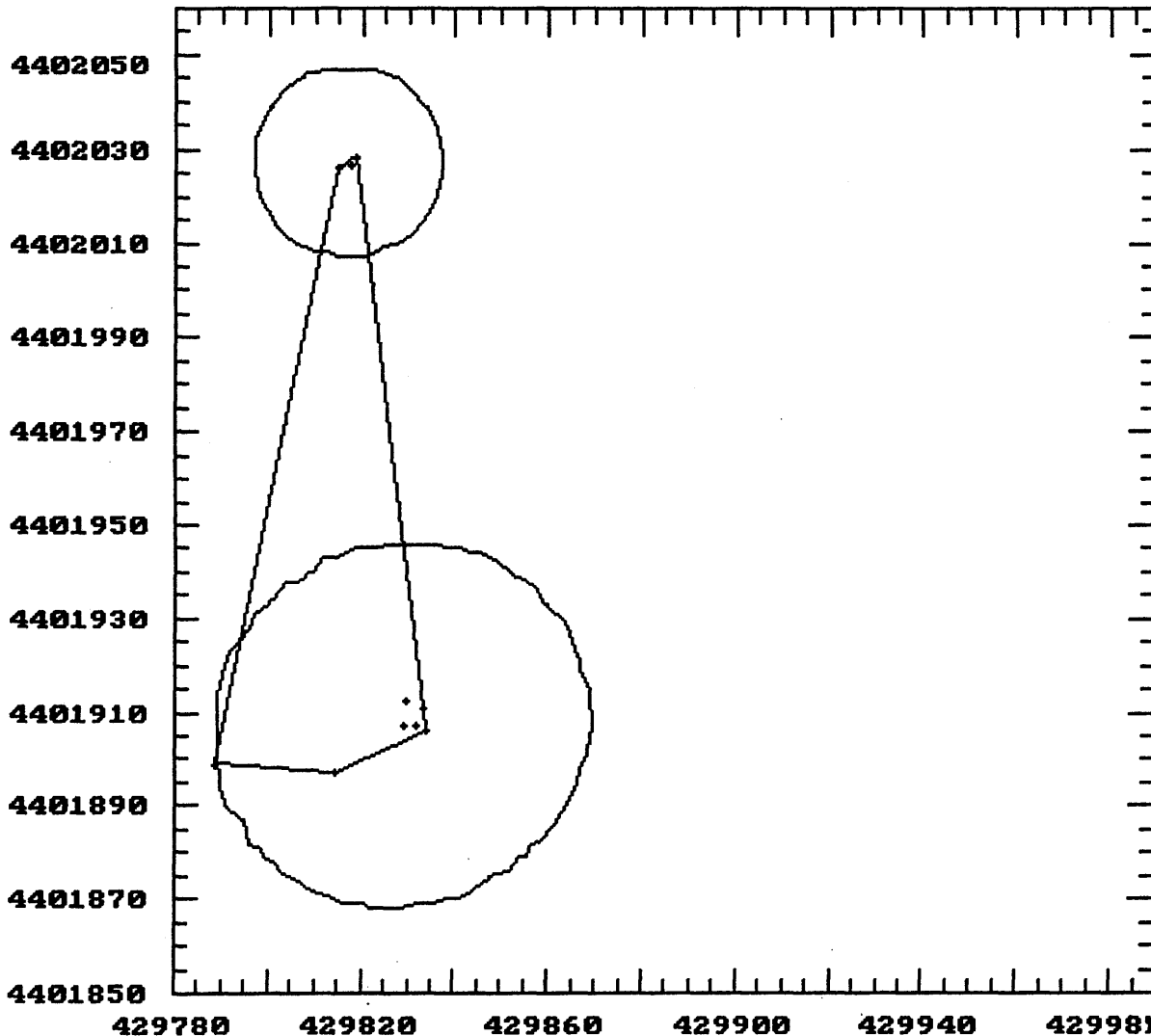

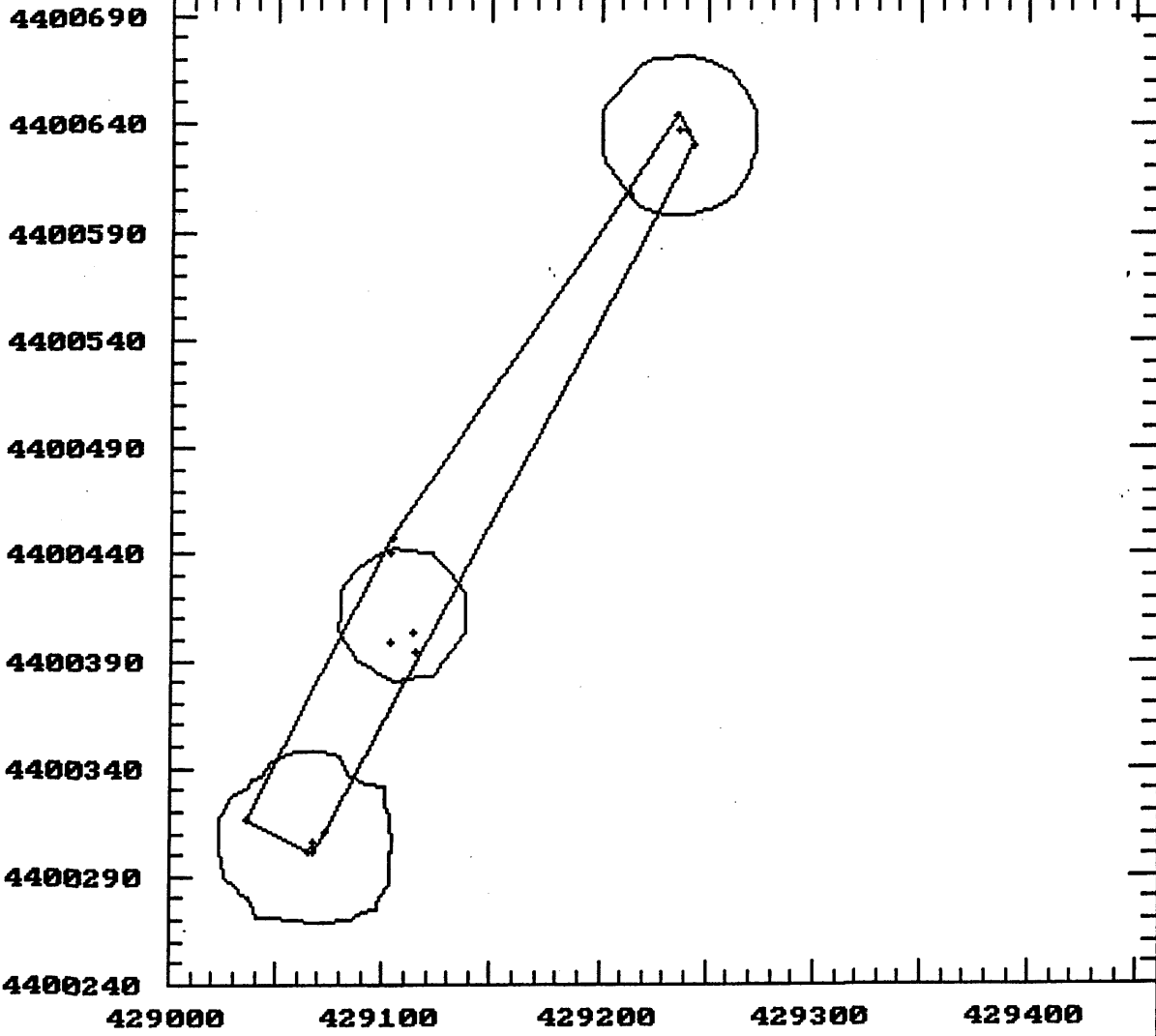

Datafile: DATA919.TXT
Output File: RS919.OUT
Display Units: meters
Adaptive Kernel
95% 12160.00 m²
Min Convex Polygon
95% 11240.00 m²
of data points: 17
Xmin: 429035.5
Xmax: 429243.4
Ymin: 4400302.
Ymax: 4400644.
Grid Size: 17.0 m
Avg. Dist: 71.7 m
Bandwidth: 50.0 m
LSCU score: -.11413E+07

APPENDIX 3.

**Breeding site water quality
results for 1997 and 1998.**

SITE	DATE	TEMP.	COND.	PH	BG ALK.	PTH ALK.	EDTA HARD.	Al	As	Cd	Cu	Fe	Mn	Pb	Se	Zn
ABOVE TRICKLE PARK RES 215GM1	08/03/98	12.3	50.5	7.82	28.0		31.0	132	<10	<0.20	4.2	1710	26.2	<5.0	<5.0	<5.0
BEAVER POND 215 GM2	08/03/98	12.4	127.5	8.04	80.0		81.6	223	<10	<0.20	4.5	1096	287.0	<5.0	<5.0	5.2
BROWN'S CREEK	08/22/97	10.1	41	7.45	21.0		32.4	32	<10	<0.20	2.3	448	56.7	<5.0	<5.0	<5.0
COLLEGIATE PEAKS	08/23/97	9.2	67	7.63	37.8		49.6	80	<10	<0.20	1.4	369	17.8	<5.0	<5.0	5.6
COLLEGIATE PEAKS LOWER POND	05/28/98		83.8			46.0	57.2	137	<10	<0.20	1.1	760	21.5	<5.0	<5.0	<5.0
COLLEGIATE PEAKS MIDDLE POND	05/28/98		71.6			34.8	45.4	66	<10	0.21	1.5	395	17.7	<5.0	<5.0	<5.0
CUCUMBER GULCH	06/18/97	21.8	44	7.08	14.2		19.0	83	<10	<0.20	1.4	368	17.7	<5.0	<5.0	5.5
CUCUMBER GULCH	06/24/98							59	<10	<0.20	1.6	192	12.5	<5.0	<5.0	<5.0
DENNY CREEK	08/23/97	8.8	38	7.51	23.0		33.8	224	<10	0.33	8.4	2280	45.1	5.7	<5.0	26.7
DENNY CREEK	05/28/98							104	<10	<0.20	<1.0	262	13.1	<5.0	<5.0	<5.0
DIAMOND PARK	06/27/97	24.0	73	7.53	30.6		36.8	184	<10	<0.20	3.3	886	82.4	<5.0	<5.0	8.0
ECLAIR URAD DONUT AREA	10/02/97	11.5	1154	3.2				34710	18	13.38	31.9	<10	8850.7	55.0	5.9	<5.0
FOUR MILE CREEK CHAFFEE, CO	08/19/97	9.6	47	8.12	21.5		26.3	442	<10	<0.20	1.6	1558	106.0	<5.0	<5.0	<5.0
FOUR MILE CREEK CHAFFEE, CO	08/04/98		53.2			22.6	30.2	145	<10	<0.20	83.3	1302	110.6	<5.0	<5.0	10.1
FOUR MILE CREEK CHAFFEE, CO	09/19/98		63.8			27.6	36.0	254	<10	<0.20	1.3	2188	122.3	<5.0	<5.0	<5.0
GUNNISON TRIANGLE PASS	06/19/98	14.4	11.9	6.5	8.6		9.8	176	<10	<0.20	1.2	406	15.9	<5.0	<5.0	5.4
HARTENSTEIN LAKE	08/30/97	10.1	18	6.93	10.6		17.2	72	<10	<0.20	<1.0	162	3.7	<5.0	<5.0	<5.0
HARTENSTEIN LAKE	09/07/98		27.4			13.8	20.8	74	<10	<0.20	1.8	470	16.5	<5.0	<5.0	6.2
HARTENSTEIN LAKE	07/13/99		15.1			8.2	10.6	66	<10	<0.20	1.2	95	3.4	<5.0	<5.0	<5.0
HERMAN GULCH	05/28/97							2471	<10	<0.20	7.1	1441	38.2	<5.0	<5.0	21.2
HERMAN GULCH	06/24/97		92	7.21	19.8		29.8	181	<10	0.26	3.1	685	264.5	<5.0	<5.0	<5.0
HERMAN GULCH	05/20/98	12.1	100.0	7.23	34.2		127.20	159	<10	0.26	1.9	1047	286.4	<5.0	<5.0	<5.0
HERMAN GULCH	05/20/98	12.1	100.0	7.23	34.2		127.20	179	<10	0.30	2.4	1415	621.8	<5.0	<5.0	<5.0
HERMAN GULCH	07/23/98	12.5	100.0	8.10	48.6	4.8	200.2	175	<10	<0.20	2.2	102	4.7	<5.0	<5.0	5.6
HERMAN GULCH	08/22/98		589			59.4	174.2	103	<10	<0.20	<1.0	265	13.2	<5.0	<5.0	<5.0
HERMAN GULCH (RUT)	06/24/97		711	7.30	61.6		189.6	419	<10	0.33	4.3	1400	225.4	<5.0	<5.0	7.2
HOLY CROSS S UPPER POOL EAGLE	07/31/98		16.1			8.2	9.0	127	<10	<0.20	1.1	26	2.1	<5.0	<5.0	6.4
JL2 SUMMIT CO	06/29/98							36	<10	<0.20	2.4	33	5.8	<5.0	<5.0	<5.0
JUMPER CREEK	05/21/98	12.5	51.6	6.75	29.8		34.0	611	<10	<0.20	1.5	323	8.2	<5.0	<5.0	<5.0
JUMPER CREEK	08/18/98		81.2			42.6	50.2	21	<10	<0.20	1.0	121	2.4	<5.0	<5.0	<5.0
KROENKE LAKE	08/29/97	10.5	22	6.93	10.4		25.4	150	<10	0.22	4.0	861	14.3	<5.0	<5.0	8.2
KROENKE LAKE	06/30/98							63	<10	<0.20	1.6	142	10.1	<5.0	<5.0	<5.0
LILY PAD LAKES TRAIL	07/01/98							87	<10	<0.20	1.7	1355	94.4	<5.0	<5.0	7.3
LOST LAKE BOULDER, CO	08/22/97	20.8	46	6.98	17.4		27.4	290	<10	<0.20	3.6	437	17.9	<5.0	<5.0	11.0
LOST LAKE BOULDER, CO	08/18/98		48.3			24.2	34.0	38	<10	<0.20	1.2	253	12.2	<5.0	<5.0	6.9
MORGANS GULCH CHAFFEE, CO	09/06/97	12.1	52	6.98	28.2		39.6	52	<10	<0.20	2.7	2442	243.7	<5.0	<5.0	6.0
MORGANS GULCH CHAFFEE, CO	06/15/98		32.9			17.4	19.2	73	<10	<0.20	1.0	204	2.4	<5.0	<5.0	<5.0
MOUNT BETHEL	06/02/97							343	<10	<0.20	2.8	208	6.3	<5.0	<5.0	<5.0
MOUNT BETHEL	06/16/97							204	<10	<0.20	7.2	131	10.0	<5.0	<5.0	5.0
MOUNT BETHEL	05/20/98	11.8	39.7	7.51	22.8		30.20	200	<10	<0.20	1.5	151	3.8	<5.0	<5.0	<5.0
MOUNT BETHEL	07/23/98	14.4	67.4	8.66	38.4		48.2	20	<10	<0.20	<1.0	37	4.1	<5.0	<5.0	<5.0
MOUNT BETHEL	08/22/98		83.5			44.8	54.0	24	<10	<0.20	<1.0	67	6.4	<5.0	<5.0	<5.0
N. TEN MILE CREEK NT6	06/22/98							27	<10	<0.20	2.7	115	13.3	<5.0	<5.0	<5.0
N. TEN MILE HIGHEST	06/23/97	22.0	70	7.55	35.0		39.4	28	<10	<0.20	<1.0	103	7.1	<5.0	<5.0	<5.0
N. TEN MILE RELOCATION POND	06/23/97	22.8	56	7.22	19.8		27.6	79	<10	<0.20	2.1	227	13.3	<5.0	<5.0	8.2
N. TEN MILE UPPER	06/23/97	21.9	63	7.42	30.4		36.4	132	<10	<0.20	1.5	583	48.9	<5.0	<5.0	16.2
N. TEN MILE UPPER LITTLE POND	06/23/97	21.8	105	7.5	58.2		59.4	80	<10	<0.20	<1.0	1356	122.2	<5.0	<5.0	42.8
N. TENMILE CREEK NT4,5,&6	06/22/98							34	<10	<0.20	1.6	120	9.2	<5.0	<5.0	<5.0
N. TENMILE CREEK NT5	06/22/98							18	<10	<0.20	<1.0	151	30.2	<5.0	<5.0	<5.0
NORTH WILLOW CREEK	07/09/98	16.0	25.1	6.5	13.0		16.8	152	<10	<0.20	1.9	299	15.3	<5.0	<5.0	<5.0
PERU CREEK	07/15/97	22.3	80	7.12	18.2		35.6	58	<10	0.41	10.3	410	61.0	5.3	<5.0	242.5

SITE	DATE	TEMP.	COND.	PH	BG ALK.	PTH ALK.	EDTA HARD.	Al	As	Cd	Cu	Fe	Mn	Pb	Se	Zn
POLE CREEK #15	06/15/97							225	<10	<0.20	1.5	286	24.5	<5.0	<5.0	<5.0
POLE CREEK #4	06/09/97	21.2	61	7.10	28.6		31.2	306	<10	<0.20	1.1	301	15.0	<5.0	<5.0	<5.0
POND AT EGELSTON	08/03/98	12.5	74.2	8.27	42.4		44.0	117	<10	<0.20	1.0	100	10.8	<5.0	<5.0	<5.0
POND S OF MESA/DELTA LINE E85	08/04/98	12.5	17.1	7.87	8.8		19.6	67	<10	<0.20	2.0	122	11.4	<5.0	<5.0	6.6
SAYRES GULCH CHAFFEE CO	09/06/97	10.5	92	7.1	57.4		62.0	68	<10	<0.20	<1.0	45	1.7	<5.0	<5.0	<5.0
SAYRES GULCH CHAFFEE CO	09/13/98		112.1			59.2	76.6	56	<10	<0.20	1.8	203	19.2	<5.0	<5.0	<5.0
SECOND POND ABOVE TRICK215GM12	08/03/98	13.2	38.5	7.66	17.6		23.6	40	<10	<0.20	1.3	208	21.1	<5.0	<5.0	<5.0
SNAKE RIVER SR2	06/25/98							13	<10	<0.20	1.5	75	18.0	<5.0	<5.0	10.8
SNAKE RIVER SR3	06/25/98							14	<10	<0.20	2.4	18	15.9	<5.0	<5.0	110.9
SODA CREEK	06/09/97	21.5	20	7.17	7.4		14.4	174	<10	<0.20	2.1	110	9.5	<5.0	<5.0	7.4
SOUTH COTTONWOOD CHAFFEE, CO	06/01/98		109.7			57.6	69.2	66	<10	<0.20	1.4	221	5.7	<5.0	<5.0	<5.0
SOUTH COTTONWOOD CHAFFEE, CO	09/07/98		106.1			55.6	70.0	84	<10	<0.20	2.6	463	7.6	<5.0	<5.0	<5.0
SOUTH COTTONWOOD WEST CHAFFEE	08/30/98							24	<10	<0.20	<1.0	1800	109.5	<5.0	<5.0	<5.0
STRAIT CREEK	06/26/98							38	<10	<0.20	3.7	81	10.3	<5.0	<5.0	<5.0
TRIANGLE PASS	06/29/98	11.2	23.4	8.39	5.0	6.2	18.4	54	<10	<0.20	<1.0	217	4.7	<5.0	<5.0	<5.0
TRIANGLE PASS	07/27/98	12.0	29.0	7.56	3.6	11.2	19.2	137	<10	<0.20	1.1	373	19.3	<5.0	<5.0	<5.0
TRIANGLE PASS	08/24/98		40.5			19.8	29.2	83	<10	<0.20	1.6	287	23.2	<5.0	<5.0	<5.0
TRIANGLE PASS	09/30/98		55.1			28.6	35.8	67	<10	<0.20	1.6	464	17.3	<5.0	<5.0	6.9
URAD HENDERSON ANN'S POND	06/10/97							2553	<10	2.21	13.2	1706	1264.6	57.8	<5.0	412.5
URAD-HENDERSON 2 POND	05/14/97		1128	7.68	268.0		365.0	3111	<10	1.89	5.4	1055	<1.0	7.7	6.3	1284.6
URAD-HENDERSON 2 POND	07/22/98	14.2	181.3	7.20	51.2		44.8	306	<10	0.78	3.1	44	1484.2	<5.0	<5.0	225.8
URAD-HENDERSON ANN'S POND	05/27/98	10.9	112.6	5.8	5.6		22.8	2856	<10	7.28	20.2	292	4344.5	14.6	<5.0	1225.5
URAD-HENDERSON ANN'S POND	07/08/98	12.3	39.7	7.04	14.0		25.4	537	<10	0.26	8.0	545	278.8	20.5	<5.0	48.5
URAD-HENDERSON DONUT	05/27/98	10.8	57.1	7.28	4.8		34.2	372	<10	0.72	3.2	139	1549.6	6.1	<5.0	185.3
URAD-HENDERSON DONUT	07/07/98	13.3	57.1	7.19	15.8		32.6	212	<10	<0.20	2.9	84	148.1	<5.0	<5.0	41.0
URAD-HENDERSON ERIN'S POND	05/15/97		307	7.04	14.0		208.6	1492	<10	0.93	9.8	937	2612.6	12.0	<5.0	330.5
URAD-HENDERSON HESBO	05/15/97		80	7.72	22.8		49.2	421	<10	<0.20	1.5	221	244.4	<5.0	<5.0	8.2
URAD-HENDERSON HESBO	05/28/98	11.5	102.6	7.45	44.4		69.4	106	<10	<0.20	1.8	75	258.1	<5.0	<5.0	9.7
URAD-HENDERSON HESBO	07/21/98	14.3	100.0	6.94	99.4		146.4	284	<10	<0.20	3.6	250	2397.9	<5.0	<5.0	38.4
URAD-HENDERSON JS POND (STMNT)	07/22/98	14.2	181.3	7.20	51.2		181.3	262	<10	0.33	17.5	601	3437.9	5.7	<5.0	32.1
URAD-HENDERSON POWER ALLEY	05/15/97		64	7.79	2.04		64	1112	<10	<0.20	2.4	606	49.0	<5.0	<5.0	28.6
URAD-HENDERSON POWER ALLEY	05/28/98	11.1	102.6	7.40	20.6		32.8	142	<10	<0.20	2.4	129	55.7	<5.0	<5.0	30.3
URAD-HENDERSON POWER ALLEY	07/08/98	13.1	58.8	6.98	25.6		37.2	23	<10	<0.20	2.0	236	150.3	<5.0	<5.0	32.1
URAD-HENDERSON TREATMENT	05/28/98	11.7	100.0	7.23	35.8		253.22	176	<10	0.35	5.6	77	279.0	<5.0	<5.0	24.9
URAD-HENDERSON TREATMENT	07/08/98	13.2	100.0	6.75	97.2		503.0	29	<10	1.27	8.6	160	2662.7	<5.0	<5.0	52.3
URAD-HENDERSON UPPER URAD	06/25/97							553	<10	1.14	6.1	239	<1.0	<5.0	<5.0	468.2
URAD-HENDERSON UPPER URAD	07/08/98	15.4	100.0	6.66	11.8		633.2	390	<10	0.62	5.9	143	<1.0	5.9	10.7	426.9
VINTAGE BELOW HEND CLEAR CREEK	05/15/97		135	7.41	20.2		47.0	267	<10	0.43	3.5	209	218.9	<5.0	<5.0	144.8

SITE	DATE	CALC. EXCEEDS METAL HARD. STANDARDS
ABOVE TRICKLE PARK RES 215GM1	08/03/98	61 Fe
BEAVER POND 215 GM2	08/03/98	74 Al,Fe
DENNY CREEK	08/23/97	23 Al,Cu,Fe,Pb
DIAMOND PARK	06/27/97	27 Al
ECLAIR URAD DONUT AREA	10/02/97	104 Al,Cd,Cu,Pb,Mn
FOUR MILE CREEK CHAFFEE, CO	08/19/97	21 Al,Fe
FOUR MILE CREEK CHAFFEE, CO	08/04/98	20 Cu,Fe
FOUR MILE CREEK CHAFFEE, CO	09/19/98	24 Al,Fe
GUNNISON TRIANGLE PASS	06/19/98	6 Al,Cu
HARTENSTEIN LAKE	07/13/99	6 Cu
HERMAN GULCH	05/28/97	18 Al,Cu,Fe
HERMAN GULCH	06/24/97	200 Al
HERMAN GULCH	05/20/98	179 Al,Fe
HERMAN GULCH	05/20/98	116 Al,Fe
HERMAN GULCH	07/23/98	6 Al,Cu
HERMAN GULCH (RUT)	06/24/97	168 Al,Fe
HOLY CROSS S UPPER POOL EAGLE	07/31/98	5 Cu
JUMPER CREEK	05/21/98	25 Al
KROENKE LAKE	08/29/97	12 Cd,Cu
LILY PAD LAKES TRAIL	07/01/98	35 Fe
LOST LAKE BOULDER, CO	08/22/97	20 Al,Cu
MORGANS GULCH CHAFFEE, CO	09/06/97	58 Fe
MOUNT BETHEL	06/02/97	19 Al
MOUNT BETHEL	06/16/97	22 Al,Cu,Pb
MOUNT BETHEL	05/20/98	24 Al
N. TEN MILE UPPER LITTLE POND	06/23/97	50 Fe
NORTH WILLOW CREEK	07/09/98	11 Al,Cu
PERU CREEK	07/15/97	28 Cu,Pb,Zn
PERU CREEK	06/25/98	31 Cu,Zn
PINGREE PARK TWIN LAKES U POND	07/24/98	10 Al,Cu,Fe
POLE CREEK #15	06/15/97	28 Al
POLE CREEK #4	06/09/97	26 Al
POND S OF MESA/DELTA LINE E65	08/04/98	7 Cu
SNAKE RIVER SR3	06/25/98	43 Zn
SODA CREEK	06/09/97	6 Al,Cu
SOUTH COTTONWOOD WEST CHAFFEE	08/30/98	106 Fe
URAD HENDERSON ANN'S POND	06/10/97	30 Al,Cd,Cu,Fe,Pb,Zn,Mn
URAD-HENDERSON 2 POND	05/14/97	313 Al,Fe,Zn
URAD-HENDERSON 2 POND	07/22/98	93 Al,Zn,Mn
URAD-HENDERSON ANN'S POND	05/27/98	44 Al,Cd,Cu,Pb,Zn,Mn
URAD-HENDERSON ANN'S POND	07/08/98	19 Al,Cu,Pb,Zn
URAD-HENDERSON DONUT	05/27/98	27 Al,Cd,Pb,Zn,Mn
URAD-HENDERSON DONUT	07/07/98	27 Al
URAD-HENDERSON ERIN'S POND	05/15/97	173 Al,Pb,Zn,Mn
URAD-HENDERSON HESBO	05/15/97	38 Al
URAD-HENDERSON HESBO	07/21/98	143 Al,Mn
URAD-HENDERSON JS POND (STMNT)	07/22/98	180 Al,Mn
URAD-HENDERSON POWER ALLEY	05/15/97	27 Al
URAD-HENDERSON TREATMENT	05/28/98	254 Al
URAD-HENDERSON UPPER URAD	06/25/97	218 Al,Zn
URAD-HENDERSON UPPER URAD	07/08/98	450 Al,Zn
VINTAGE BELOW HEND CLEAR CREEK	05/15/97	42 Al,Zn

The above samples exceed Colorado's aquatic life water quality standards for the listed metals. This does not imply that tadpoles are affected by metals at these sites. These standards are applied to water samples filtered through a 0.4 micron filter. Samples containing suspended solids are likely to cause elevated levels of metals. Furthermore, these standards are designed to protect the most sensitive species. Tadpoles may be able tolerate much higher levels of metals without harm.

**Predator communities
and boreal toad breeding sites**

Lauren J. Livo
Environmental, Population, and Organismic Biology
University of Colorado
Boulder, CO 80309-0334
and
Colorado Division of Wildlife
317 W. Prospect
Fort Collins, Colorado 80526

ABSTRACT

I studied aquatic predators of tadpoles in 25 montane ponds along the Front Range of Colorado, including six ponds with current or historical records of breeding by boreal toads (*Bufo boreas*). Pond temperatures were positively correlated both with diversity of animals and with expected impact from predators of tadpole. Ponds used as boreal toad breeding sites had significantly fewer predaceous diving beetles (*Dytiscus* sp.) and tiger salamanders (*Ambystoma tigrinum*) than ponds without records of boreal toad reproduction. These findings suggest that successful boreal toad reproduction is dependent on sites that are sufficiently warm but that do not include abundant populations of important predators of tadpoles.

INTRODUCTION

Within the past 20 years, boreal toads (*Bufo boreas*) have undergone unexplained population declines in distribution and abundance in Colorado (Corn et al., 1989; Carey, 1993). Because of these declines, the Colorado Division of Wildlife listed this species as endangered in 1993 (Goettl, 1997). Surveys in 1994-1995 along the Front Range of Colorado documented boreal toads at sites that range in elevation from 2390 m to 3640 m, a range similar to historical elevation range (Livo and Yackley, 1997). In contrast, the current elevation range of breeding sites (2840 to 3280 m) may be somewhat contracted relative to the historical elevation range of breeding sites (2630 to 3350 m) (Livo and Yackley, 1997).

Boreal toad distribution was recently studied in Rocky Mountain National Park, Colorado (Corn et al., 1997). For sites occupied by at least one amphibian species, they found no significant differences between sites occupied by toads versus sites not occupied by toads in terms of physical habitat parameters, including elevation, pond pH, pond area, and pond structural and vegetation characteristics. These findings suggest that one or more biotic factors, such as the presence of particular predators, may be important in shaping the current distribution of occupied boreal toad sites. Although predation on eggs, tadpoles, or metamorphosed toads has not been suggested as a direct cause of population declines in this species in Colorado, with the reduced abundance of boreal toads, natural predation events now may be a threat to small remnant populations (Corn, 1993).

My surveys and others conducted by the Colorado Division of Wildlife of boreal toad breeding sites frequently revealed sharp declines in boreal toad tadpole numbers prior to metamorphosis. Because of noxious compounds in the skin, tadpoles in the genus *Bufo* are generally regarded as unpalatable to many predators (Voris and Bacon, 1966; Kruse and Stone, 1984; Hews and Blaustein, 1985; Peterson and Blaustein, 1991). However, in laboratory trials, several aquatic predators consumed boreal toad tadpoles: predaceous diving beetle larvae (*Dytiscus* sp.), various adult diving beetles (*Dytiscus dauricus*, *Agabus tristis*, *Rhantus binotatus*, and *Graphoderus occidentalis*), medium and large dragonfly larvae (family Aeshnidae), and tiger salamander larvae (*Ambystoma tigrinum*) (Livo, 1998; Jones et al., in press). Backswimmers (Notonectidae) were noted as predators of boreal toad tadpoles in the Pacific Northwest (Kiesecker et al., 1996).

Two aquatic predators, *Dytiscus* sp. and *Ambystoma tigrinum*, are of particular interest. In laboratory experiments, boreal toad tadpoles were significantly more vulnerable to predation by *Dytiscus* larvae than were chorus frog (*Pseudacris triseriata*) tadpoles, a hylid anuran broadly sympatric with *Bufo boreas* in the southern Rocky Mountains but which shows little evidence of population declines (Livo, 1998; Corn et al., 1989; Corn et al., 1997). Similarly, *Bufo boreas* tadpoles were significantly more vulnerable to predation by *Dytiscus* larvae than tadpoles of another hylid anuran, *Pseudacris regilla* (Peterson and Blaustein, 1992). *Dytiscus* larvae consume boreal toad tadpoles at several boreal toad breeding sites (pers. obs.), and *Bufo boreas* tadpoles reared in sections of pools with greater densities of *Dytiscus* larvae metamorphose at smaller body

sizes than do tadpoles in sections of pools with reduced densities of *Dytiscus* larvae (Livo, unpublished data).

The second predator, *Ambystoma tigrinum* larvae, readily consumes *Bufo boreas* tadpoles in a laboratory setting. Its geographic range overlaps broadly with that of *Bufo boreas* (Livo, 1998) and there are historical records of *Ambystoma tigrinum* larvae present at the same site as *Bufo boreas* larvae. Within the past 10 years, however, there have been no reports in Colorado of these two species reproducing in the same pond at the same time despite this broad overlap of geographic ranges. It is demonstrated by the lack of evidence of decline of *Ambystoma tigrinum*, and regular surveys of *Bufo boreas* breeding sites (Corn et al., 1989; Corn et al., 1997) (Colorado Division of Wildlife, unpublished data).

Boreal toad tadpoles must reach metamorphosis in a single season and do not over winter as tadpoles (Fetkavich and Livo, 1998). Consequently, the thermal environment probably excludes successful reproduction by boreal toads at cold ponds. Cold pond temperatures are also expected to limit occupation by predators of boreal toad tadpoles.

If temperature and predator gradients have a role in determining which ponds can be occupied successfully by boreal toads, then there may be detectable differences between ponds currently occupied by boreal toads and those not occupied by boreal toads. In particular, all other things being equal, sites with current boreal toad populations may contain lower densities of important tadpole predators compared to sites that lack boreal toads.

The purpose of this study was to test the following hypothesis. Within the elevation ranges occupied by boreal toads, there is a predator gradient associated with pond temperatures, and that successful boreal toad reproduction is excluded both from ponds that are too cold as well as from ponds with high potential impact from aquatic predators. If trapping data and selected physical parameters from a series of montane ponds can be used to discriminate between ponds used as breeding sites by boreal toads from those without records of breeding activities, then logistic regression procedures may serve to identify ponds that could be considered for use as boreal toad restoration sites.

MATERIALS AND METHODS

Between 25 June and 31 August 1998, I sampled aquatic predator communities in 26 montane ponds in Boulder, Clear Creek, Gilpin, and Larimer counties, Colorado (Figure 1). Ponds ranged in elevation between 2450 and 3180 meters. Each pond was sampled twice, first in late June or July, and a second time in August. Geographically proximate ponds were grouped together and sampled on the same dates. Sampling dates for proximate groups of ponds were randomly assigned. Results were pooled for the two sampling periods. One shallow pond was discarded from the analysis because a strong wind on the second sampling date blew several of the traps out of the water.

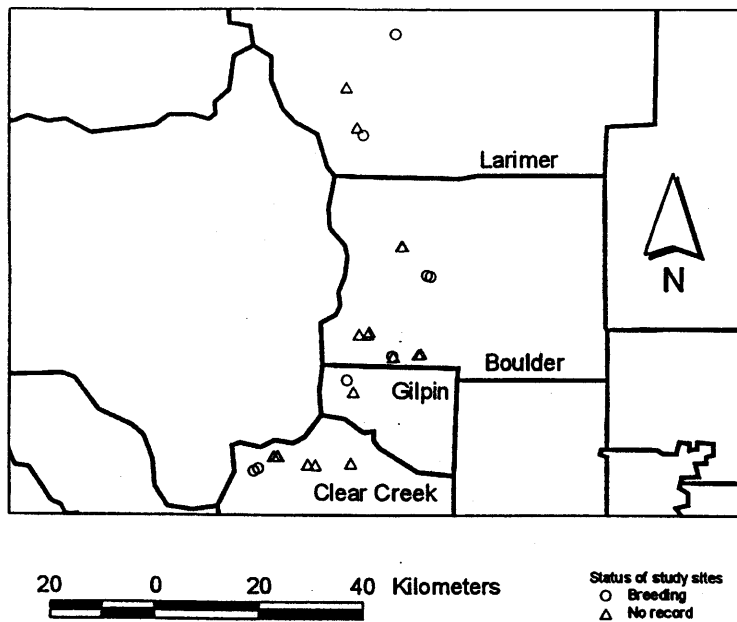

Figure 1. Study sites; circles represent *Bufo boreas* breeding sites and triangles represent sites with no record of *Bufo boreas* breeding.

For each sample, I placed eight aquatic traps around the perimeter of the pond. The traps were Ranger Products 25 x 25 x 43-cm collapsible funnel traps with 3-cm openings and 1.6-mm mesh. To minimize trap mortality, I positioned each trap so that the openings were submerged but at least part of the upper surface of the trap was above water. Non-baited traps remained in place for 24 hours to collect both diurnal and nocturnal animals. I made the following assumptions regarding the trapping: 1) traps sampled non-overlapping areas of a pond, 2) organisms already present in the traps had no effect on the likelihood that subsequent organisms would enter the trap, 3) organisms small enough to escape through the trap mesh are not important tadpole predators, and 4) the trap openings were sufficiently large to allow passage of the largest of aquatic tadpole predators. A Stowaway Boxcar® temperature logger collected temperature data at 15-minute intervals; these data were used to calculate mean pond temperature for the 24-hour period.

I used U.S. Geological Survey 1:24,000 topographic maps to determine pond elevations; measurements in English units were converted to metric prior to use in the analysis. I estimated pond length and width with a rangefinder; for ponds with one or more axis >75 m, I measured pond length and width from a USGS 1:24,000 topographic map. Pond perimeter was calculated as an ellipse with the length and width estimating the major and minor axes.

Trap contents were emptied into plastic containers for sorting. I identified trap contents to a minimum of family level. Vertebrates caught in the traps were measured and released. Coleoptera larvae and adults were preserved in the field with alcohol, as were selected voucher specimens of other invertebrate taxa. Specimens were deposited in the C. P. Gillette Museum of Arthropod Diversity, Colorado State University, Ft. Collins, Colorado.

I estimated diversity at the family level for each pond using the Shannon-Wiener diversity index (Smith, 1974), but excluded any trapped *Bufo boreas* tadpoles from these calculations. Previous laboratory trials indicated that different predator groups differed in their likely impact on boreal toad tadpole populations (Livo, 1998; Jones et al., in press). To obtain an estimate of the potential effect of predators in a pond, I tallied predators by group (such as *Dytiscus* larvae, Notonectidae, and so on), then multiplied these numbers by a daily consumption rate factor for that group (Table 1). This variable was termed "predator impact." Except for notonectids, I based consumption rates on the mean number of tadpoles consumed per predator per day from laboratory trials (Livo, 1998; Livo, unpubl. data). Notonectid consumption rates were estimated from another study (Cronin and Travis, 1986). All other animals (excluding *Bufo boreas* tadpoles) in the traps were tallied as non-predators.

Table 1. Estimated daily rates of consumption of *Bufo boreas* tadpoles by selected predators.

Predator group	Estimated consumption rates
<i>Dytiscus</i> larvae	6.4
Dytiscid (non- <i>Dytiscus</i>) larvae	0.25
Small adult Coleoptera	0.25
Medium and large adult Coleoptera	0.5
Anisoptera larvae	4.0
Notonectidae	3.7
<i>Ambystoma tigrinum</i>	6.3

I used the SAS logistic regression procedure to discriminate between two classes of ponds: those with current or historical records of breeding by boreal toads, and those with no such record.

RESULTS

The five variables were used in the logistic regression procedure were, elevation in meters (mean = 2779 ± S.E. 41 m, $n = 25$), mean pond temperature (mean = 15.3 C ± S.E. 0.6 C, $n = 25$), diversity (mean = 22 ± S.E. 3, $n = 25$), total number of *Dytiscus* sp. (mean = 6.4 ± 2.1, $n = 25$), and total number of *Ambystoma tigrinum* (mean = 7.6 ± 4.0, $n = 25$).

Compared to other logistic regression analyses with different and/or more variables, this analysis produced among the best categorization of sites with among the lowest scores for the Akaike's Information Criterion (AIC = 29.554 for Intercept Only, = 21.718 for Intercept and Covariates). Using these variables, the logistic regression procedure correctly classified 23 of the 25 ponds (92 percent). One of six "breeding" sites was incorrectly classified as a "no record" site, whereas one of 19 "no record" sites was classified as a "breeding" site. In *t*-tests comparing the variables used in the logistic regression procedure, only elevation differed significantly between ponds with boreal toad breeding and those without records of breeding (Table 2). Figure 2 illustrates the distribution of predicted probabilities that specific ponds are boreal toad breeding sites versus those predicted to have no record of boreal toad breeding.

Table 2. Variable means, associated Chi Square values, and comparison between boreal toad breeding sites and sites without record of boreal toad breeding.

Predictor	Parameter estimate (± SE)	χ^2	Breeding (means, n = 19) (±SE)	Non-breeding (means, n = 6) (±SE)	<i>T</i>
<i>Dytiscus</i>	-0.18 ± 0.20	0.5	4.67 ± 2.12	6.95 ± 2.64	0.46
<i>Ambystoma tigrinum</i>	-0.11 ± 0.15	0.49	0.50 ± 0.50	9.79 ± 5.20	1.78
Mean temperature	1.79 ± 2.84	2.85	17.13 ± 0.60	14.75 ± 0.78	-1.64
Elevation	0.01 ± 0.01	3.23	2930 ± 84	2731 ± 42	-2.26*
Diversity	-0.047 ± 0.09	0.27	24.6 ± 5.3	21.2 ± 3.87	-0.44
Overall model $\chi^2 = 17.836$, $df = 5$, $p < 0.01$					
* $p < 0.05$					

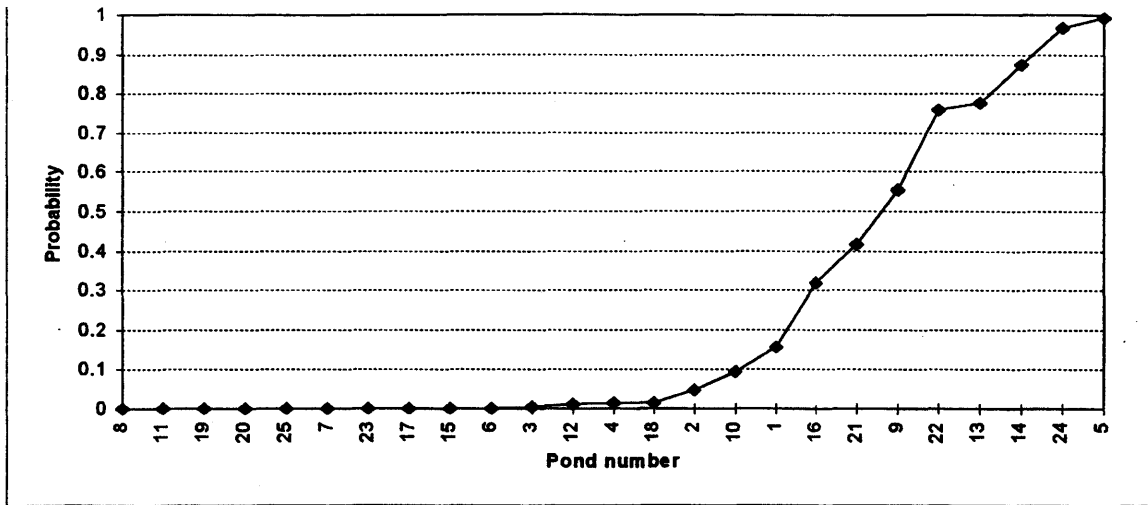

Figure 2. Distribution of predicted probabilities for pond status (ponds with a probability score > 0.5 are expected to be boreal toad breeding sites, whereas ponds with a probability score < 0.5 are expected to have no record of boreal toad breeding). Pond numbers are displayed along the x-axis.

There was a highly significant correlation between mean pond temperature and total diversity ($r = 0.641$, $p < 0.001$, $df = 23$). However, there was no significant correlation among other variables used in the logistic regression (Table 3).

Although predator impact scores were not used in the logistic regression, there was a significant correlation between mean pond temperature and predator impact score ($r = 0.464$, $p < 0.05$, $df = 23$). With respect to correlation's between pond perimeter and tallies of individual predators, only the number of odonate larvae was significantly correlated ($r = 0.477$, $p < 0.05$, $df = 23$). Correlation's approached significance for the tally of large Coleoptera ($r = 0.392$, $p = 0.053$, $df = 23$) and Notonectids ($r = 0.390$, $p = 0.055$, $df = 23$).

Excluding the six coldest ponds (all with mean pond temperatures < 14.5 C), I compared the total number of individuals of *Dytiscus* sp. plus *Ambystoma tigrinum* in *Bufo boreas* breeding ponds versus those ponds with no record of breeding. In this comparison, *Bufo boreas* breeding ponds had significantly fewer of these predators (mean total in breeding ponds = 5.167 ± 4.792 S.E., mean total in non-breeding ponds = 24.462 ± 25.644 S.E., $t = 2.616$, $df = 17$, $p < 0.05$) (Figure 3). However, there was no significant difference between boreal toad breeding ponds and ponds without record of boreal toad breeding when these ponds were compared with the generalized predator impact scores (mean predator impact score for breeding ponds = 82.69 ± 124.38 S.E., mean predator impact score in non-breeding ponds = 168.87 ± 168.87 S.E., $t = 0.763$, $df = 17$, $p > 0.05$).

Table 3. Correlation matrix for variables used in logistic regression (probabilities in parentheses).

	Mean pond temperature	Elevation (m)	Number of <i>Dytiscus</i> sp.	Number of <i>Ambystoma tigrinum</i>	Total diversity
Mean pond temperature	1.00	00.12 (0.580)	0.365 (0.072)	0.108 (0.609)	0.641*** (0.0006)
Elevation (m)		1.00	-0.011 (0.958)	-0.093 (0.659)	-0.345 (0.091)
Number of <i>Dytiscus</i> sp.			1.00	-0.114 (0.586)	0.179 (0.392)
Number of <i>Ambystoma tigrinum</i>				1.00	0.192 (0.358)
Total diversity					1.00
***p < 0.001					

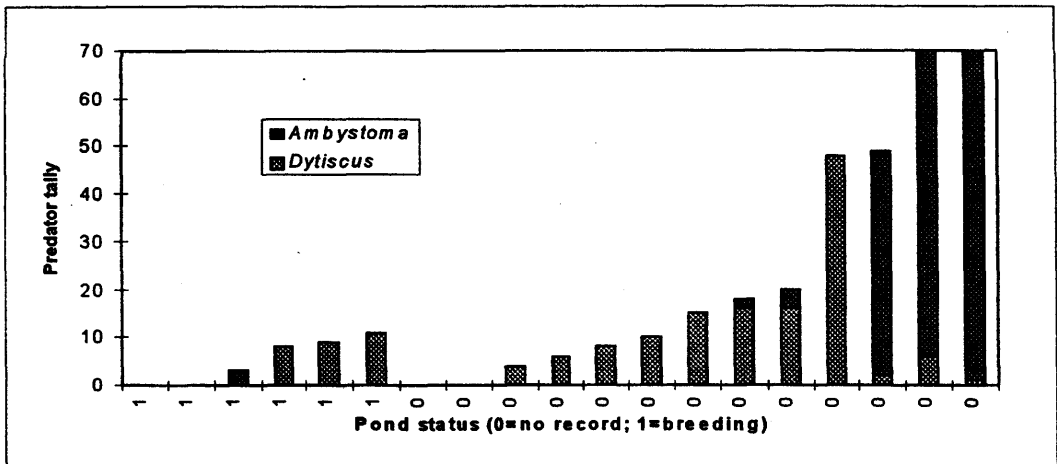

Figure 3. Comparison of total numbers of *Ambystoma tigrinum* and *Dytiscus* larvae and adults in boreal toad breeding ponds (pond status = 1) and ponds with no record of boreal toad breeding (pond status = 0).

DISCUSSION

Although predation has not been suggested as a cause of the widespread geographic decline in boreal toad populations, the results of this study indicate that predator communities do play a role in shaping the distribution of breeding sites for boreal toads. The logistic regression procedure served to successfully discriminate between most ponds considered boreal toad breeding sites and ponds without record of breeding by boreal toads. With respect to the abundance of *Dytiscus* sp. and *Ambystoma tigrinum*, when cold ponds were excluded, ponds with current or historical records of breeding by boreal toad had significantly lower scores for these predators than ponds that lacked current records.

Some caution is necessary in interpreting the results of this study because of uncertainty with the historic record. There were insufficient sites to have a third category comprised entirely of historical sites, so these sites were grouped with sites having current breeding reports. Because boreal toad populations have declined, some ponds identified in this study as having no record of boreal toad breeding may have been used in the past by toads. Tadpoles tend to be difficult to identify to species, and there was little pressure for biologists in past decades to make comprehensive notes concerning the presence or identity of tadpoles at various sites. Consequently, the distribution of ponds used as breeding sites by boreal toads is certainly underrepresented compared to the distribution of adult toads as documented through both museum specimens and literature reports. Further, other ponds identified as having record of occupation by boreal toads in the past may now have altered thermal or biotic characteristics. Finally, at least two of the ponds currently used as breeding sites by boreal toads are of recent anthropogenic origin, so predator populations may be artificially low at these sites.

Tadpole vulnerability to predation is not constant through time, and at large body sizes, tadpoles may escape predation by some gape-limited predators such as notonectids. However, larger tadpoles may represent preferred prey items by other predators such as birds, which were not considered in this analysis. Further, some predators may persist in a pond for relatively short periods of time, whereas others are present throughout the time tadpoles are present.

Predator abundance, noted for boreal toad breeding sites in this study, might actually represent the higher end of the spectrum. Boreal toads in Colorado often select temporary pools and other ephemeral sites in which to breed, and these sites may have especially low predator abundance. However, the traps used in this study require a minimum pond depth of approximately 18 cm, resulting in the exclusion from this study of several small, shallow pools used as breeding sites by boreal toads.

Finally, the results of this study may enhance the ability of wildlife managers to assess a series of potential restoration sites and identify those with the highest probability of successful survival of tadpoles. The logistic regression procedure identified a pond (Bald Mountain Spring, pond 14) without record of boreal toad breeding as a predicted breeding site. Compared to the other ponds without boreal toad breeding records, this pond might represent a suitable restoration

site for boreal toads, although other features of the local environment must be considered (e.g., hibernacula may not be available, predators of metamorphosed toads may be limiting, and so on). Aquatic trapping programs such as those conducted for this study could be implemented in areas being considered for restoration efforts, such as Grand Mesa in western Colorado. Most habitat evaluations associated with reintroduction efforts concentrate on features important to the survival of adult animals. Adult survival obviously remains an important consideration. However, this study emphasizes the need to consider habitats from the tadpoles' point of view, because any successful reestablishment of a species requires adequate survival of all stages in its life history.

ACKNOWLEDGEMENTS

Funding for this project was provided through Great Outdoors Colorado and the Colorado Division of Wildlife. I thank Mark Jones (Colorado Division of Wildlife) for facilitating this research. Most ponds were on Roosevelt/Arapahoe National Forest lands; I am also grateful to Boulder County Open Space, Rocky Mountain National Park, and several private landowners for permission to sample ponds on their lands. David Chiszar and David Armstrong of the University of Colorado commented on early drafts of this paper. Greg Carey (University of Colorado) provided statistical advice. Boris Kondratieff (Colorado State University) generously provided identifications of the invertebrates. Steve Wilcox provided computer support for several aspects of this work.

REFERENCES

- Carey, C. 1993. Hypothesis concerning the causes of the disappearance of boreal toads from the mountains of Colorado. *Conservation Biology* 7:355-362.
- Corn, P. S. 1993. *Bufo boreas* (boreal toad). Predation. *Herpetological Review* 24:57.
- Corn, P. S., M. L. Jennings, and E. Muths. 1997. Survey and assessment of amphibian populations in Rocky Mountain National Park. *Northwestern Naturalist* 78:34-55.
- Corn, P. S., W. Stolzenburg, and R. B. Bury. 1989. Acid precipitation studies in Colorado and Wyoming: interim report of surveys of montane amphibians and water chemistry. U. S. Fish and Wildlife Service Biological Report 80(40.26):1-56.
- Cronin, J. T., and J. Travis. 1986. Size-limited predation on larval *Rana areolata* (Anura: Ranidae) by two species of backswimmer (Insecta: Hemiptera: Notonectidae). *Herpetologica* 42:171-174.
- Fetkavich, C., and L. J. Livo. 1998. Late-season boreal toad tadpoles. *Northwestern Naturalist* 79:120-121.
- Goettl, J. P., Jr. 1997. Boreal toad (*Bufo boreas*) recovery plan (southern Rocky Mountain population). Colorado Division of Wildlife 45.
- Hews, D. K., and A. R. Blaustein. 1985. An investigation of the alarm response in *Bufo boreas* and *Rana cascadae* tadpoles. *Behavioral and Neural Biology* 43:47-57.
- Jones, M. S., J. P. Goettl, and L. J. Livo. in press. *Bufo boreas* (boreal toad). Predation. *Herpetological Review*.
- Kiesecker, J. M., D. P. Chivers, and A. R. Blaustein. 1996. The use of chemical cues in predator recognition by western toad tadpoles. *Animal Behavior* 52:1237-1245.
- Kruse, K. C., and B. M. Stone. 1984. Largemouth bass (*Micropterus salmoides*) learn to avoid feeding on toad (*Bufo*) tadpoles. *Animal Behavior* 32:1035-1039.
- Livo, L. J. 1998. Predators of larval *Bufo boreas*. *Colorado-Wyoming Academy of Science* 38:32.
- Livo, L. J., and D. Yackley. 1997. Comparison of current with historical elevational range in the boreal toad, *Bufo boreas*. *Herpetological Review* 28:143-144.
- Peterson, J. A., and A. R. Blaustein. 1991. Unpalatability in anuran larvae as a defense against natural salamander predators. *Ethology Ecology & Evolution* 3:63-72.

Peterson, J. A., and A. R. Blaustein. 1992. Relative palatabilities of anuran larvae to natural aquatic insect predators. *Copeia* 1992:577-584.

Smith, R. L. 1974. *Ecology and field biology*. Harper & Row, Publishers, New York.

Voris, H. K., and J. P. Bacon, Jr. 1966. Differential predation on tadpoles. *Copeia* 1966:594-598.

**Phylogeny of the Southern Rocky Mountain group of *Bufo boreas*
based on mitochondrial DNA sequences and nuclear AFLP data**

Preliminary report to the Colorado Division of Wildlife

Anna M. Goebel, Ph.D.
Research Associate
EPOB CB 334
University of Colorado
Boulder, CO 80309
303-373-9245
goebel@spot.colorado.edu

May 7, 1999

ABSTRACT

Phylogenetic relationships within and among *Bufo boreas* of the Southern Rocky Mountain region (SRM; central Colorado and southeastern Wyoming), Utah and Idaho were examined using both mitochondrial DNA (control region sequences) and nuclear DNA (AFLP restriction site data). All toads in the SRM region were found in the same clade or cluster and both data sets identified toads in the SRM group as having significantly different gene frequencies from toads in the surrounding regions. Despite the geographic isolation of the SRM group, neither data set identified the toads in the SRM group as monophyletic (mtDNA data) or as having exclusive genetic clusters (AFLP data). MtDNA data identified several toads from northern Utah, which had retained genes found within the SRM region. Nuclear data identified genes from toads in southeastern Idaho, which fell within the same cluster as all toads in the SRM group. Support for speciation of the SRM group lies in the highly significant frequency differences, and the geographic isolation of the group.

INTRODUCTION

Previous studies of mtDNA described the mitochondrial DNA divergence of *Bufo boreas boreas* in the Southern Rocky Mountain (SRM) region (Goebel, 1996) raising the possibility that *B. b. boreas* in Colorado is a distinct species. Recent declines (Cary, 1993; Corn, 1994) of toads in this region indicated that strong conservation efforts were warranted and the toad was listed as Endangered by the State of Colorado. Evidence of speciation from genetic studies may provide further support for ongoing conservation efforts (Loeffler, 1998).

In order to examine the phylogenetic relationships of toads in the SRM region further, two related studies were undertaken. The first was to examine mtDNA of toads in regions geographically closest to those in the Southern Rocky Mountains, including Utah and southern Idaho (toads from northwestern Wyoming were examined previously). The second was to examine nuclear DNA markers from toads in the Southern Rocky Mountains as well as the geographically close regions examined with mtDNA.

MATERIALS AND METHODS

Samples were collected from localities throughout Colorado (N=203) as well as the surrounding regions in Wyoming (N=3), Utah (N=55), northeastern Nevada (N=3), southeastern Idaho (N=10), and central Idaho (N=35). Tissue collected included animals found dead in the field, blood from juveniles or adults, tadpoles, newly metamorphosed toads, and egg tissue.

Mitochondrial DNA was analyzed using sequence data from the control region obtained by direct sequencing, restriction site analyses, and analyses of Single-Stranded Conformational Polymorphisms (SSCPs). Detailed methods for analyzing mtDNA are elsewhere (Goebel, 1996; Goebel et al., 1998; Goebel, 1997).

Nuclear DNA was examined using Amplified Fragment Length Polymorphisms (AFLPs; Vos et al., 1995). Unlike other PCR-based fingerprinting methods (e. g., RAPD: random amplified polymorphic DNA; DAF: amplification fingerprinting; AP-PCR: arbitrarily primed PCR), AFLP methods are based on ligating known DNA fragments to genomic DNA and using the ligated fragments as primer sites. Thus, primer sites are perfect matches. This reduces sensitivity to reaction conditions, DNA quality, and PCR temperature profiles, all of which limit the utility of other methods (Vos et al., 1995). A reduced sensitivity was critical for this project, because collected samples were frequently from very small amounts of varied tissues and often were decayed.

AFLP analyses followed the methods detailed in Vos et al., (1995) with minor modifications from Rosendahl and Taylor (1997), Lin and Kuo (1995), Life Technologies AFLP Instruction Manual (1997), and Janssen et al., (1996). About 200 samples from the eastern portion of the range were analyzed along with 10 samples from the Northwest and Southwest

mtDNA clades (clades described in Goebel, 1996). The latter were used as outgroups. Data were collected from five independent primer pair combinations and 107 parsimony informative characters were identified for each sample.

Parsimony methods (Swofford, 1993) were used to hypothesize relationships among haplotypes identified from mtDNA. Neighbor-Joining methods (Saitou and Nei, 1987) were used to hypothesize phylogenetic relationships based on AFLP site data. Further analyses of both data sets among populations within the Southern Rocky Mountain group will be provided in the final report.

RESULTS

Mitochondrial DNA

Parsimony analyses (Figure 1) identified three major clades previously described (Goebel, 1996) including the Southern Utah Clade (Kane County), Northwest Clade (northwest Wyoming, Montana, Central and northern Idaho, and most of Oregon, Washington, coastal British Columbia and Alaska), and the Southwest Clade (California and western Nevada). All newly analyzed samples from central Idaho were found in the Northwest clade. Two samples from northern Utah were also found in the Northwest Clade. Samples from northeast Nevada were found in both the Northwest Clade and the Eastern Clade (described below).

The Eastern clade comprised most samples from southeast Idaho, northern and central Utah, and the geographically disjunct group found in central Colorado, southeast Wyoming and northern New Mexico (the Southern Rocky Mountain Group, SRM). Several minor clades were found within the Eastern Clade. Most samples from northern Utah (Box Elder, Rich, and Summit Counties) and northeastern Nevada (Elko County) were found in the basal clade identified as Northern Utah (Figure 1). However, some samples from northern Utah were found within a clade comprising all samples from the SRM group. Samples from southeastern Idaho clustered together and were basal to the clade containing all samples in the SRM group. Samples from central Utah (Piute County) formed a clade. This clade was found within the clade that included all SRM toads, but this relationship was not strongly supported. Samples from the SRM group did not form a monophyletic clade; samples from northern and central Utah (Piute County) were found to be closely related to those in the Southern Rocky Mountains. All samples from southeastern Wyoming (Albany County) were found to be closely related to those in Colorado. No samples from New Mexico were analyzed.

AFLP nuclear data

AFLP data provided characters useful for examining relationships at a wide level of genetic divergences. Many characters were shared among all samples analyzed (including the outgroups) suggesting that these data might be useful in identifying relationships among more

divergent taxa. In addition, characters unique to many individuals were identified also, suggesting that these data might be useful at very low levels, including parental testing.

Phylogenetic analysis (Figure 2) identified clades previously described (Goebel 1996) as the Southern Utah Clade (Kane County) as well as the Northwest and Southwest Clades (not shown). Nuclear data were similar to mitochondrial data in that they identified clusters for toads in central Utah (Piute Co.), Northern Utah, S. E. Idaho (Caribou Co.) and a large cluster of toads which included all samples from the SRM group. Both sets of data showed substantial differences among populations within the Southern Rocky Mountain group (preliminary analyses not shown). Nuclear data differed from mitochondrial data in the hypothesized relationships among some groups. Nuclear data suggested that toads in central Utah (Piute Co.) were more closely related to toads in northern Utah, while mtDNA identified them as most closely related to mtDNA haplotypes in the SRM group. Mitochondrial data suggested that toads in S. E. Idaho were basal to those in the SRM group, while the nuclear data placed the same toads within the SRM group.

DISCUSSION

The most significant finding of both mitochondrial and nuclear data sets was that all toads in the SRM group (over 125-200 toads analyzed with nuclear and mtDNA data respectively) fall within the same clade. The clade identified with mtDNA data was not monophyletic in that haplotypes from northern and central Utah were also found within this clade. The cluster identified with nuclear data did not include DNA from northern or central Utah toads, but did include DNA from toads in southeastern Idaho. Both sets of data reflect close historical relationships to regions in central and northern Utah as well as southeast Idaho. However toads from these different regions do not comprise a common gene pool, due to present-day geographic barriers. Lack of strict concordance between mtDNA and nuclear DNA has been seen in a variety of species and this conflict reflects different gene histories and the random nature of gene loss throughout the region. The combined data sets suggest that toad populations in the SRM region have ancestors in both central Utah as well as southeastern Idaho. The lack of monophyly or gene exclusivity of toads in the Southern Rocky Mountain region suggests that toads have been recently isolated (recent in evolutionary times) if a constant rate of evolution is assumed.

Evidence for speciation of the Southern Rocky Mountain group lies in the highly significant frequency differences of genes found in this region, and the geographic isolation of the group. Due to a variety of accepted species concepts, any delineation of species in this group will be controversial. However the genetic data, combined with the geographic isolation identify the Southern Rocky Mountain group as an independently evolving unit. This unit may be considered a Management Unit by some biologists, and a species by others. However, the independent evolution of the SRM group strongly supports an independent conservation effort for toads in this region.

Figure 1. PHYLOGENY OF THE *BUFO BOREAS* SPECIES GROUP BASED ON MITOCHONDRIAL DNA DATA. Single most parsimonious tree. Branches are drawn proportional to their length. Clade names and localities are identified within the tree. Sample sizes are based only on samples for which complete control region sequences were available. Many more samples were analyzed for each clade. For example, partial data that identified major clades were obtained for over 200 samples from the Southern Rocky Mountain group.

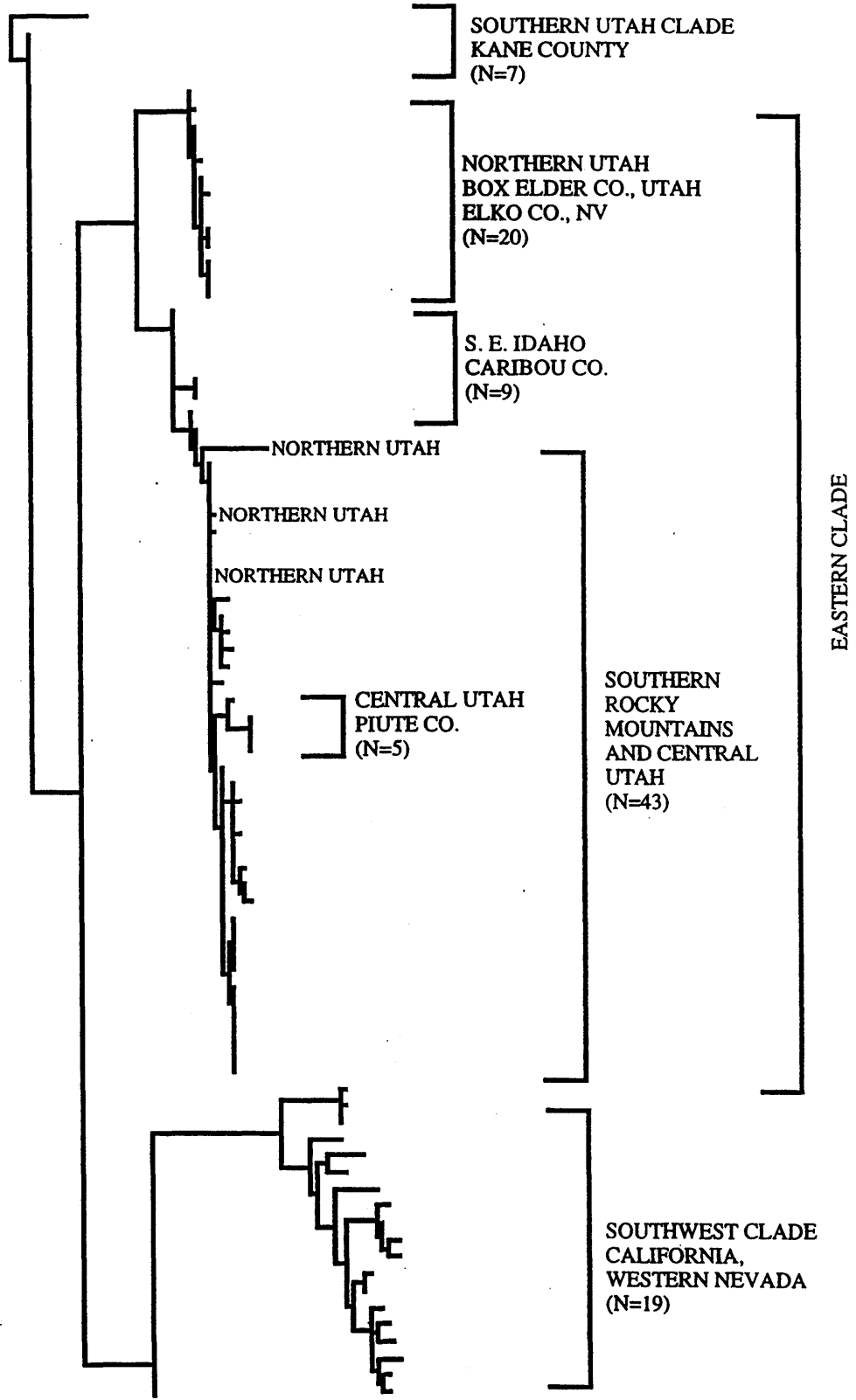

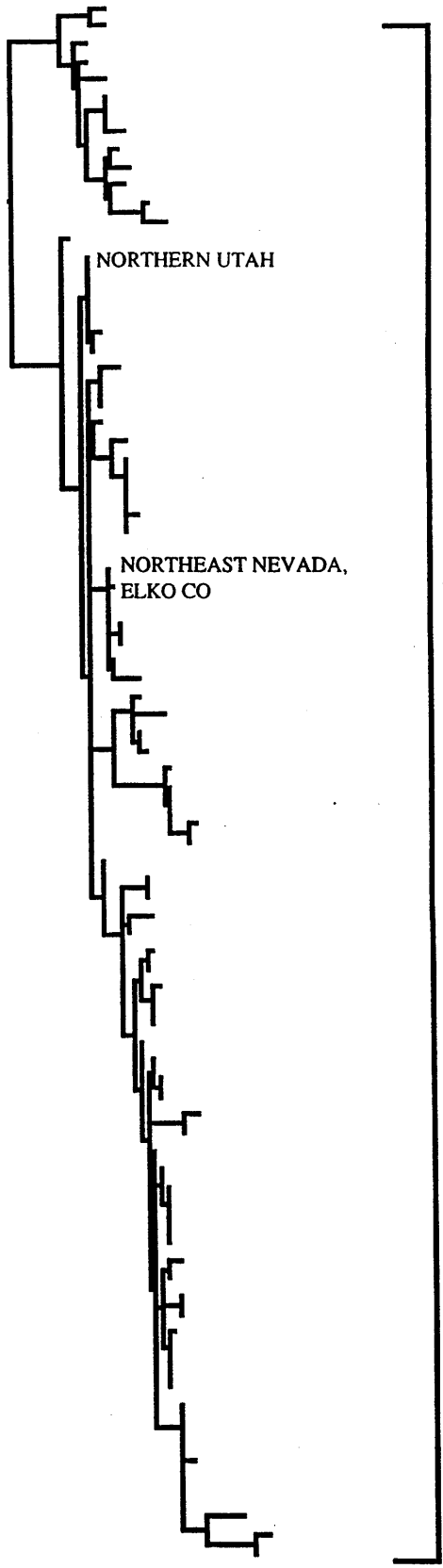

NORTHERN UTAH

NORTHEAST NEVADA,
ELKO CO

NORTHWEST CLADE
OREGON, WASHINGTON,
CENTRAL AND N. IDAHO
MONTANA, NW WYOMING
COASTAL BRITISH COLUMBIA
AND COASTAL ALASKA
(N=93)

Figure 2. PHYLOGENY OF EASTERN *BUFO BOREAS* BASED ON NUCLEAR AFLP DATA.
 Neighbor-joining tree. Localities are identified to the right of the tree. Individual samples that were found in alternate localities are identified within the tree.

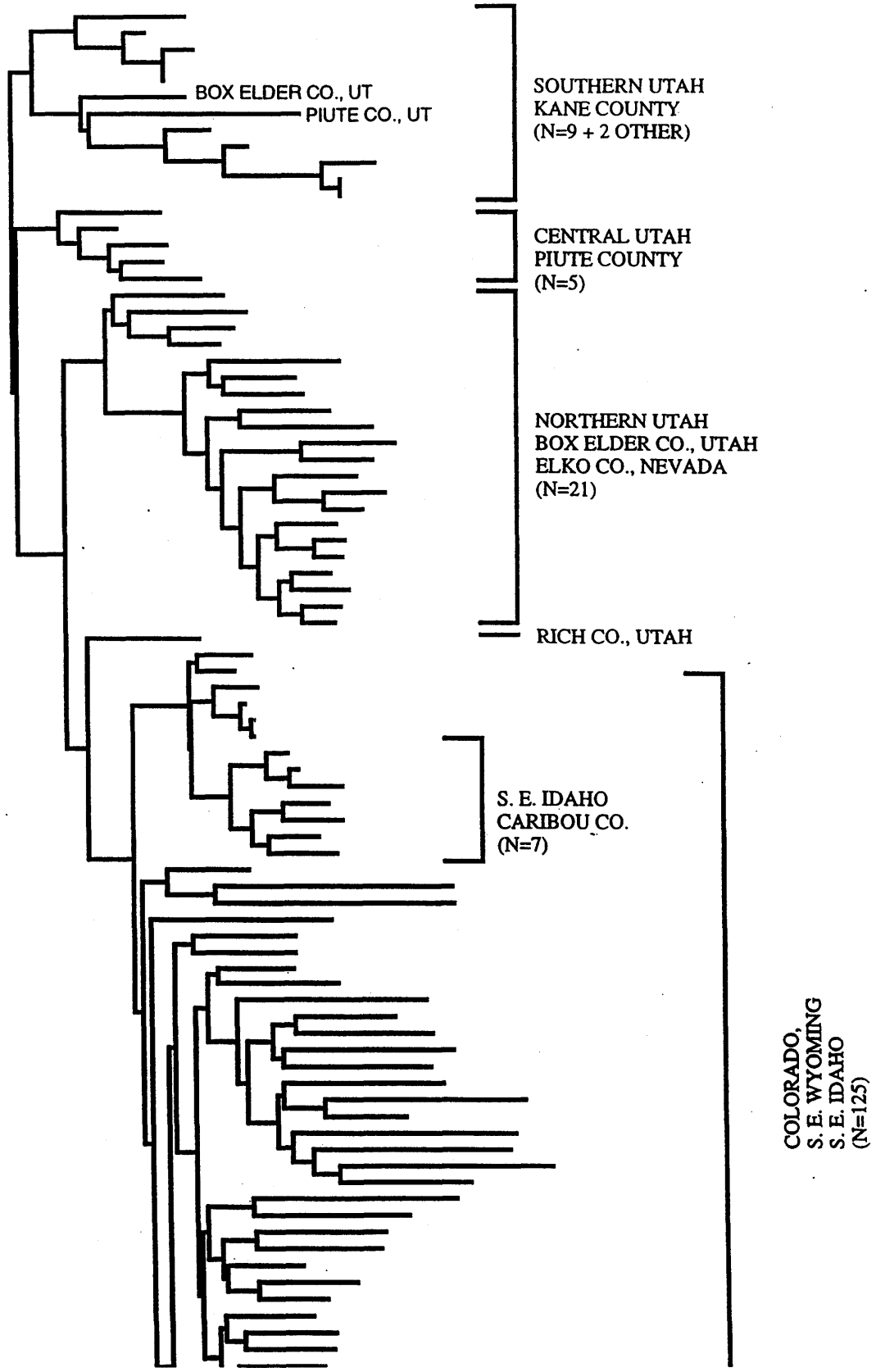

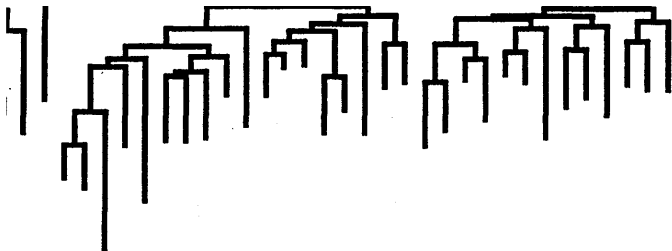

COLORADO,
S. E. WYOMING
S. E. IDAHO
(N=125)

ACKNOWLEDGEMENTS

Thanks to the many people who collected samples for genetic analyses, they are too numerous to mention in this brief report but this work could not have been done without their help. Steve Corn (Aldo Leopold Wilderness Research Institution, USGS) provided funding for mtDNA analyses of *Bufo boreas* in Idaho, Utah and surrounding regions. Mary Atz and Jody Donnelly did much of the laboratory work. Margaret Goebel entered most of the AFLP data into the computer.

REFERENCES

- Anonymous. 1997. Instruction Manual: AFLP analysis System I AFLP Starter Primer Kit. Life Technologies, Gibco, BRL.
- Cary, C. 1993. Hypothesis concerning the causes of the disappearance of boreal toads from the mountains of Colorado. *Conservation Biology* 7:355-362.
- Corn, P. S. 1994. What we know and don't know about amphibian declines in the west. Pp. 59-67 in W. W. Covington and L. F. DeBano (ed) *Sustainable Ecological Systems: Implementing an Ecological Approach to Land Management*. USDA Forest Service, Rocky Mountain Forest and Range Experiment Station, Ft. Collins, CO, General Technical Report RM-247.
- Goebel, A. M. 1997. Molecular Genetic Determination of Management Units of the Endangered Boreal Toad (*Bufo boreas*) in Colorado and Southeast Wyoming. Report to the Colorado Division of Wildlife, Denver, Colorado.
- Goebel, A. M., J. M. Donnelly and M. E. Atz. 1999. PCR primers and amplification methods for the 12S ribosomal DNA, the control region, cytochrome oxidase I, and cytochrome b in Bufonids and other Frogs, and an overview of PCR primers which have amplified DNA in amphibians successfully. *Molecular Phylogenetics and Evolution* 11:163-199.
- Goebel, A. M. 1996. Systematics and Conservation of Bufonids in North America and in the *Bufo boreas* Species Group. Dissertation. University of Colorado, Boulder, Colorado.
- Goebel, A. M. 1999. Conservation Systematics: Integrating Diversity into Systematics and Taxonomy Using Examples from North American Bufonids and the *Bufo boreas* Species Group. Accepted pending revisions.
- Janssen, P., R. Coopman, G. Huys, J. Swings, M. Bleeker, P. Vos, M. Zabeau and K. Kersters. 1996. Evaluation of the DNA fingerprinting method AFLP as a new tool in bacterial taxonomy. *Microbiology* 142:1881-1983.
- Lin, J. J. and J. Kuo. 1995. AFLP a novel PCR based assay for plant and bacterial DNA fingerprinting. *Focus* 17:66-70.
- Loeffler, C. (ed). 1998. Boreal Toad Conservation Plan and Agreement. Colorado Division of Wildlife, Denver, Colorado.

- Rosendahl S. and J. W. Taylor. 1997. Development of multiple genetic markers for studies of genetic variation in arbuscular mycorrhizal fungi using AFLP. *Molecular Ecology* 6:821-829.
- Saitou, N. and M. Nei. 1987. The neighbor-joining method: a new method for reconstructing phylogenetic trees. *Molecular Biology and Evolution* 4:406-425.
- Swofford, D. L. 1993. PAUP: phylogenetic analysis using parsimony, version 3.1. Illinois Natural History Survey, Champaign IL.
- Vos, P., R. Hogers, M. Bleeker, M. Reijans, T. van de Lee, M. Hornes, A. Frijters, J. Pot, J. Peleman, M. Kuiper and M. Zabeau. 1995. AFLP: a new technique for DNA fingerprinting. *Nucleic Acids Research* 23:4407-4414.